

CHOOSE A TOPPER

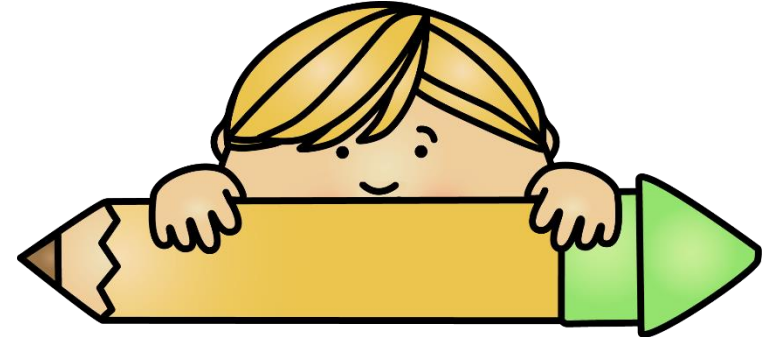

Assembly Instructions: Cut out each shape and layer the pages by their numbers with one being the first page you lay down, then two on top, etc. Add the character topper last and staple the book together. You can also glue the pages into a notebook in this same fashion.

3

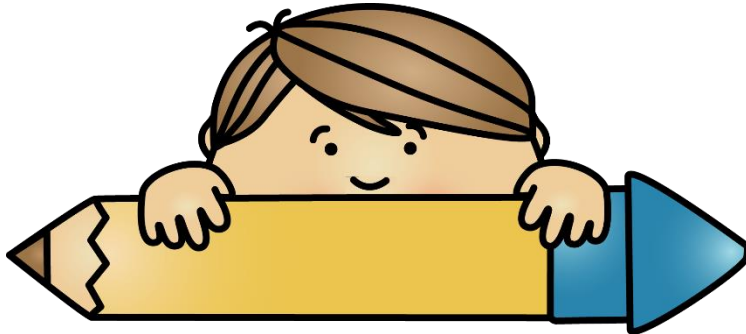
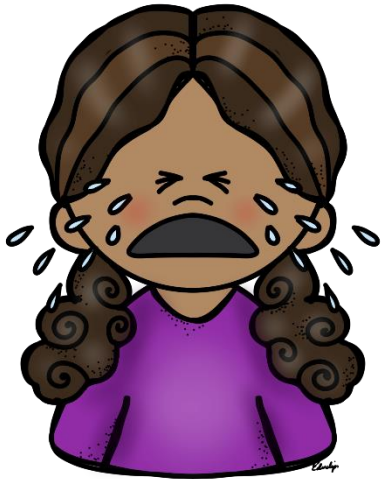

sob

S

2



sit

1



sell

4

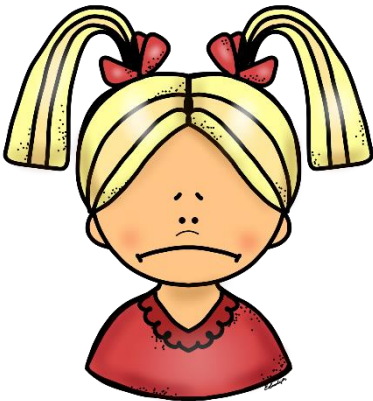

sad

5

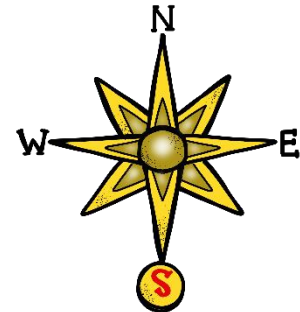

south

3

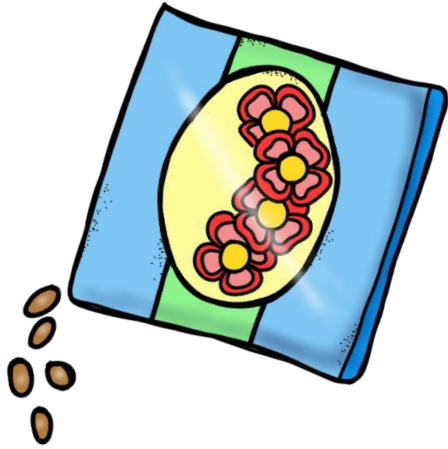

seed

S

1



sock

2

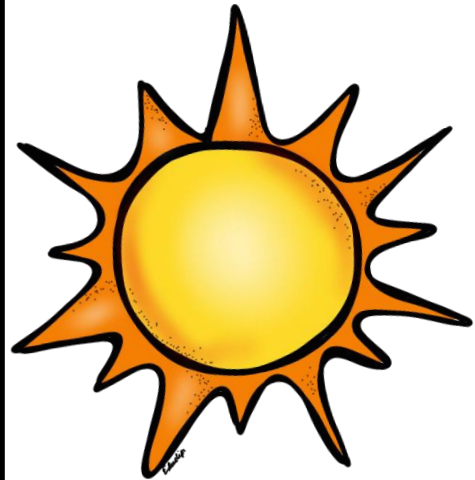

sun

4



soap

5

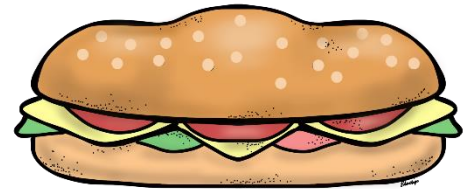

sub

3



bus

S

1

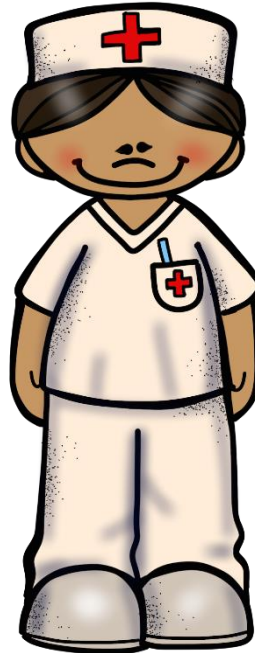

nurse

2



bounce

4

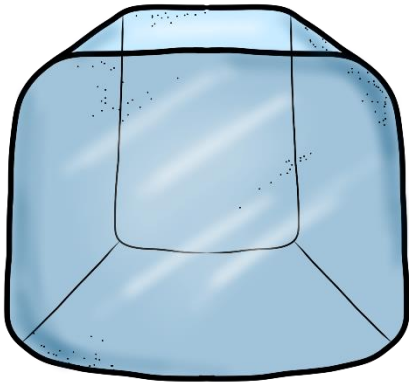

ice

5

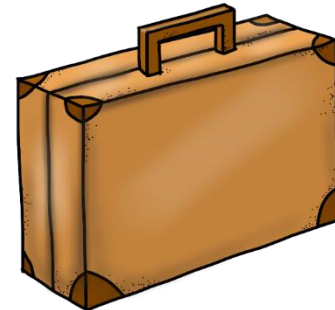

case

3



house



1



dress

2

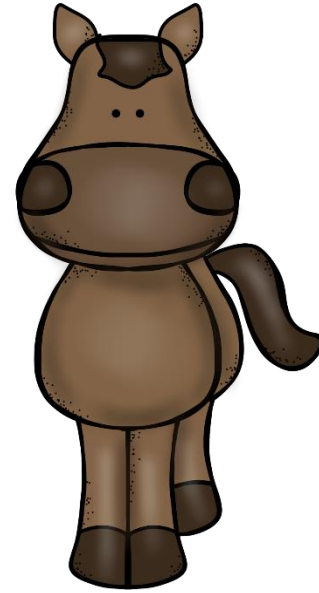

horse

4



mess

5

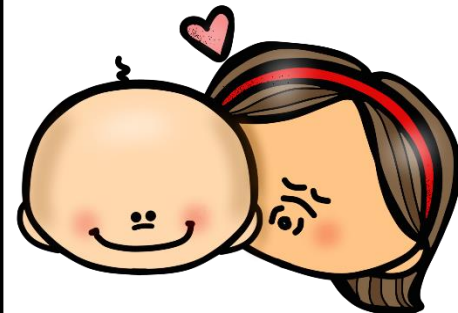

kiss

CHOOSE A TOPPER

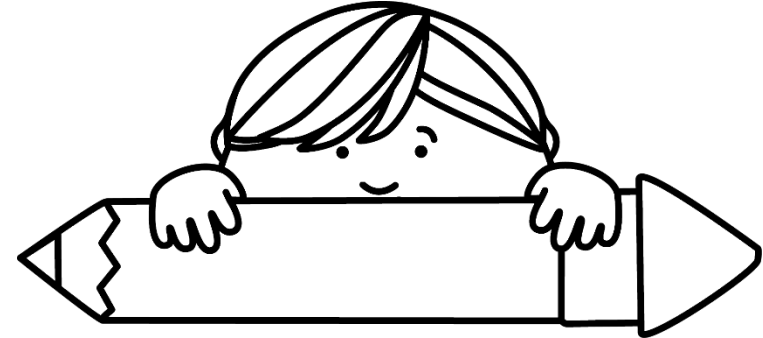
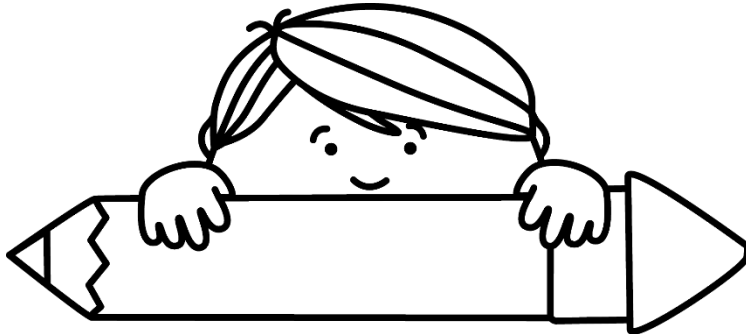
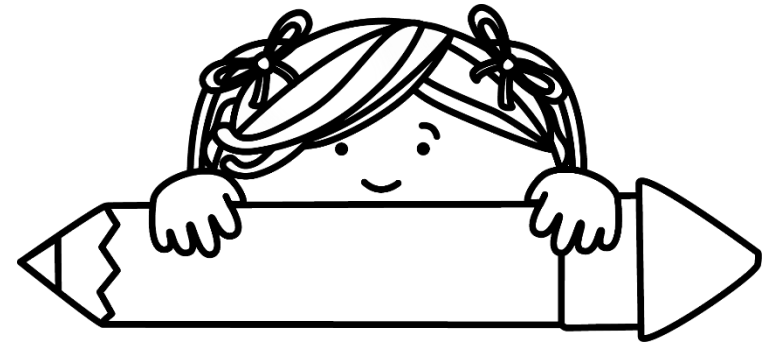
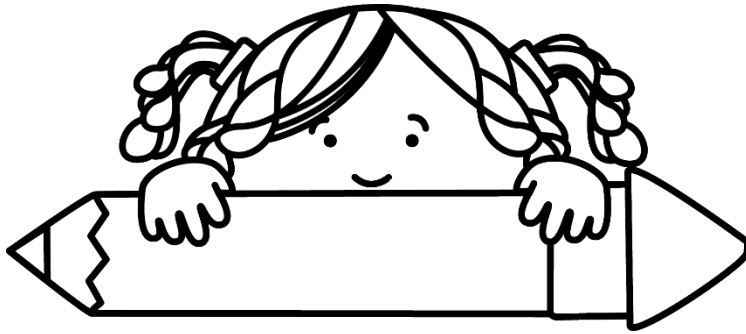

Assembly Instructions: Cut out each shape and layer the pages by their numbers with one being the first page you lay down, then two on top, etc. Add the character topper last and staple the book together. You can also glue the pages into a notebook in this same fashion.

3



sob

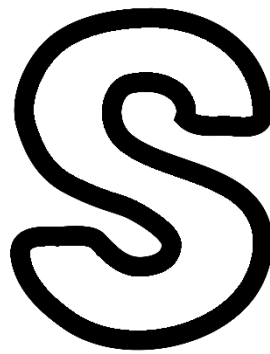

1



sell

2



sit

4



sad

5

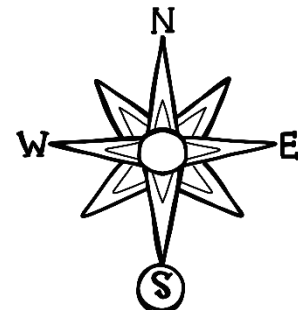

south

3

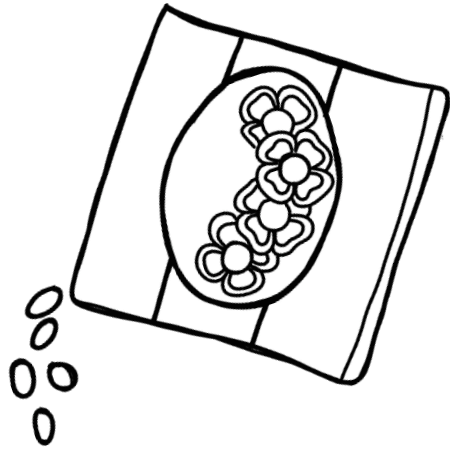

seed

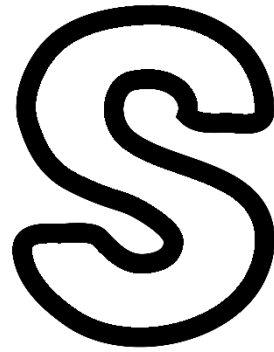

1



sock

2

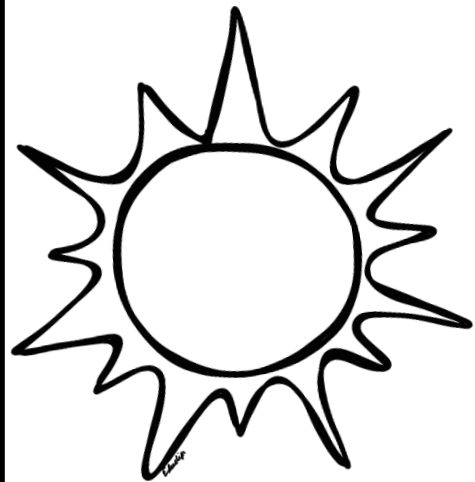

sun

4

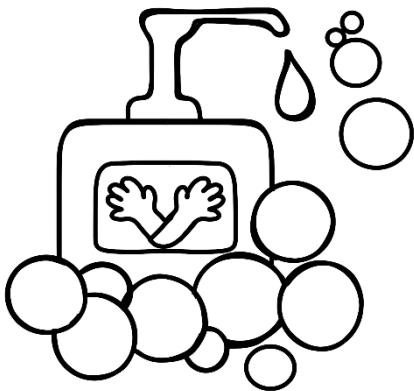

soap

5

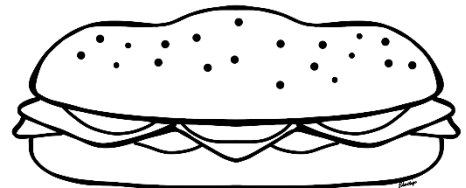

sub

3

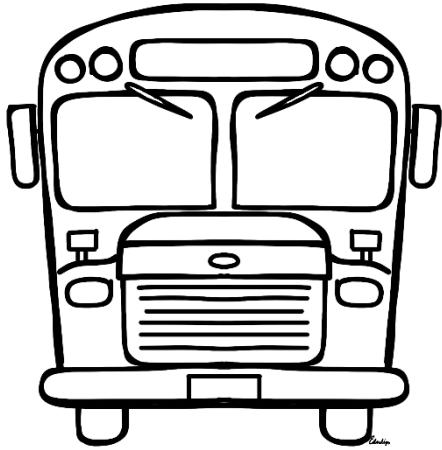

bus

4

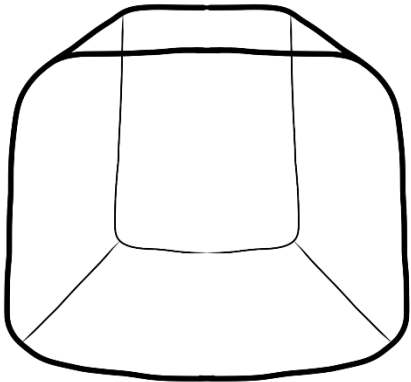

ice

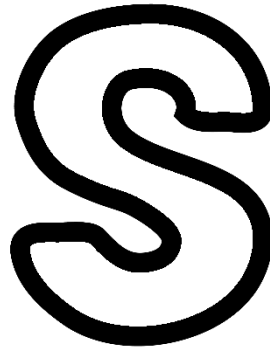

1

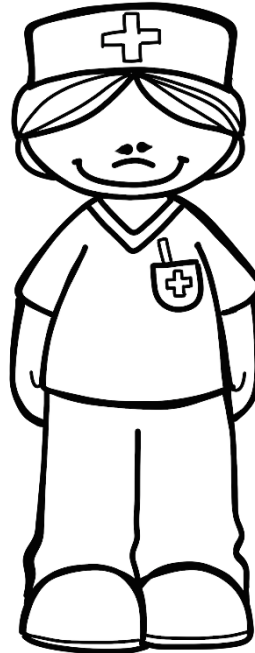

nurse

2



bounce

5

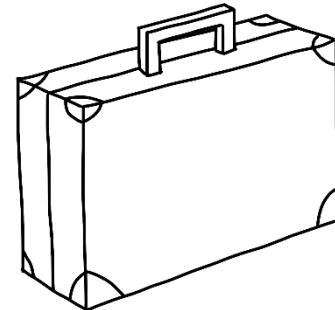

case

3



house

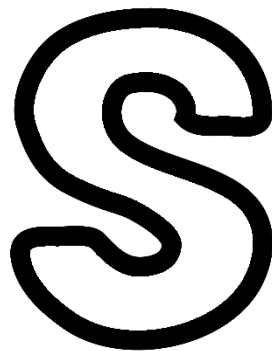

1

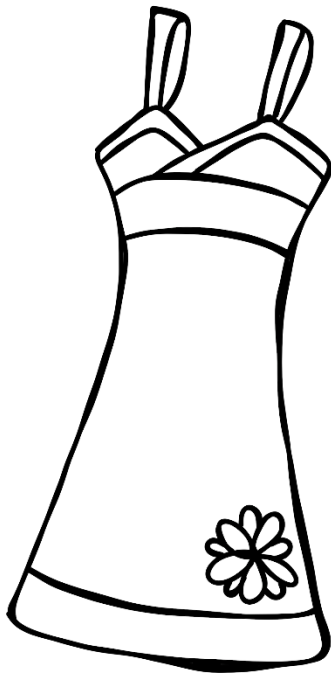

dress

2



horse

4



mess

5

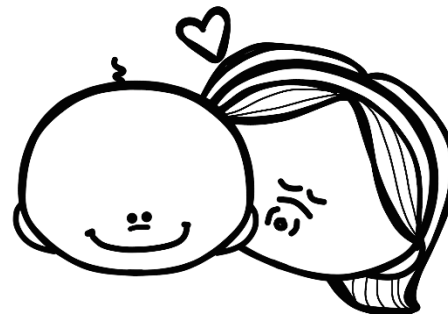

kiss