

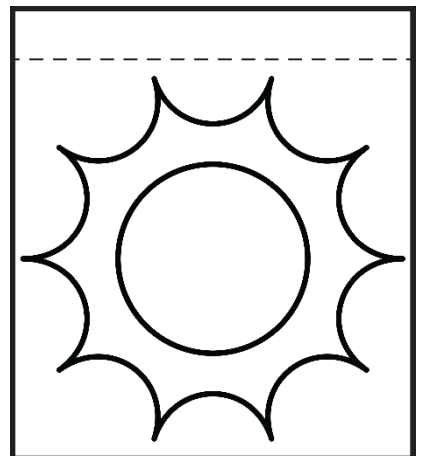

The following templates can be used as simple lift-the-flap activities to practice single articulation sounds.

However, they will also work at the phrase level. i.e. "boy under sun" or "The boy is running under the sun."

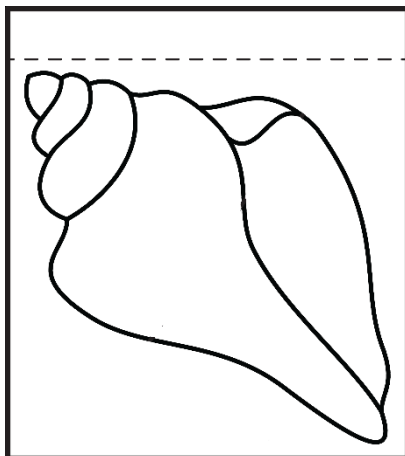

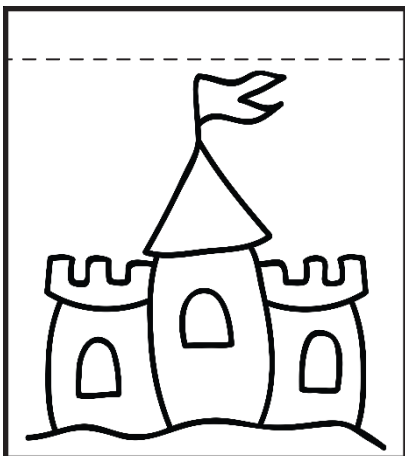
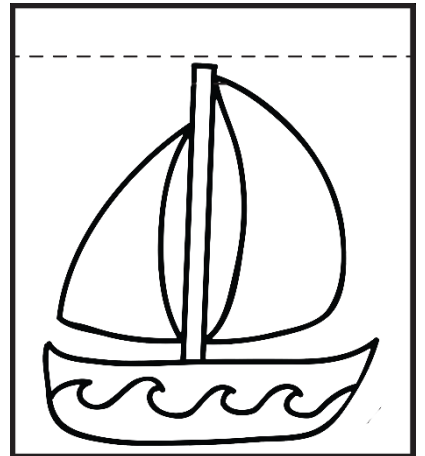
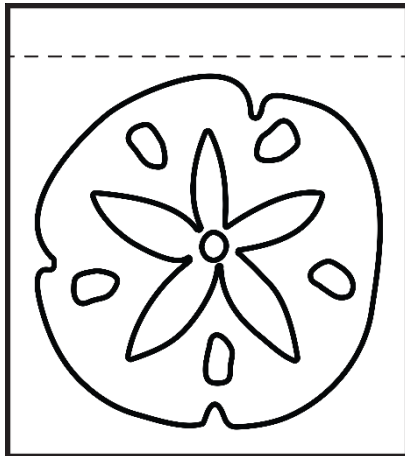
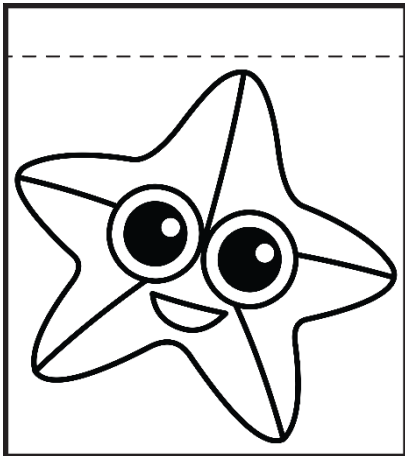
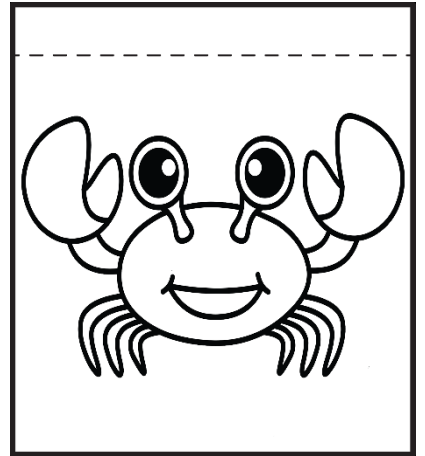
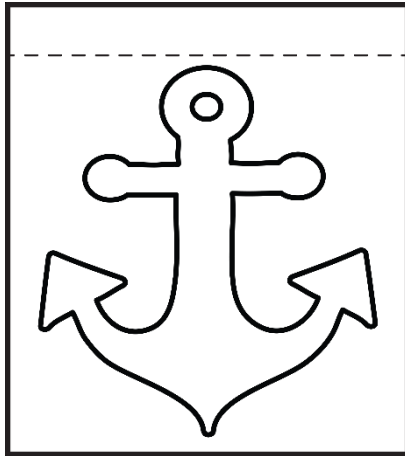
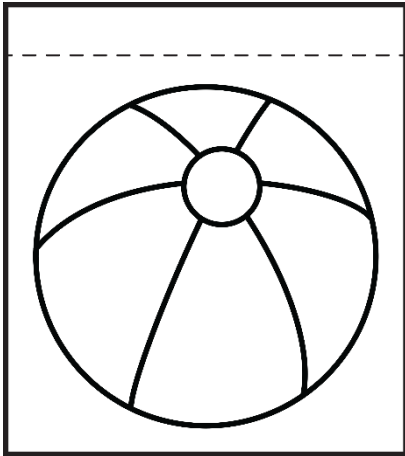

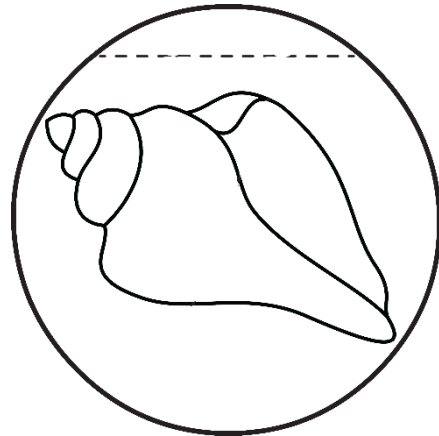
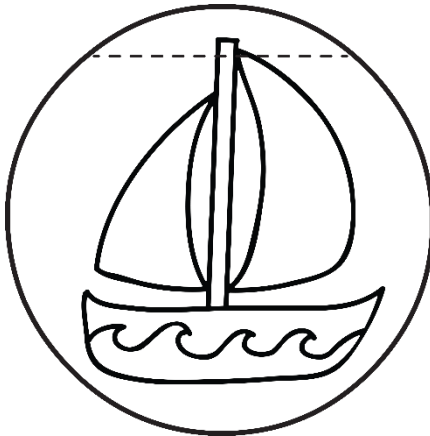
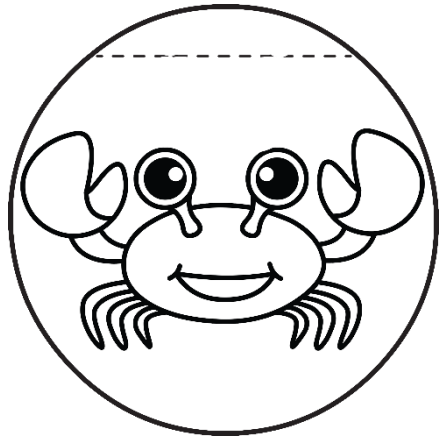
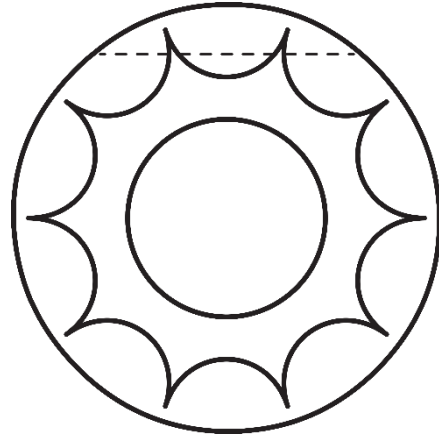
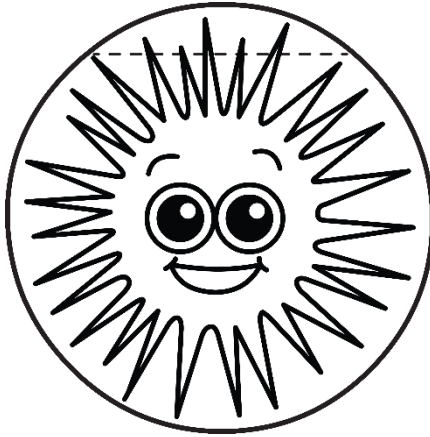
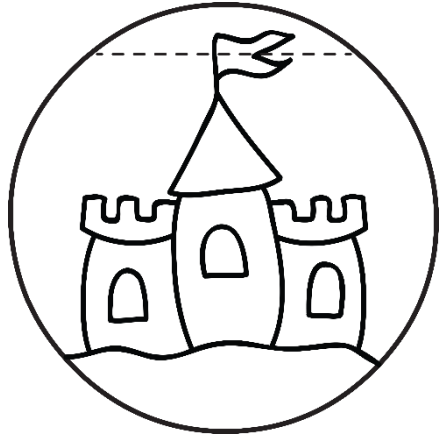
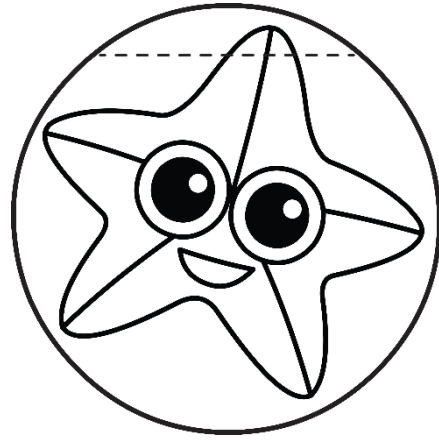
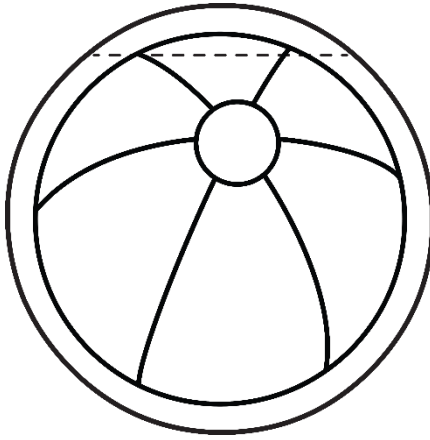
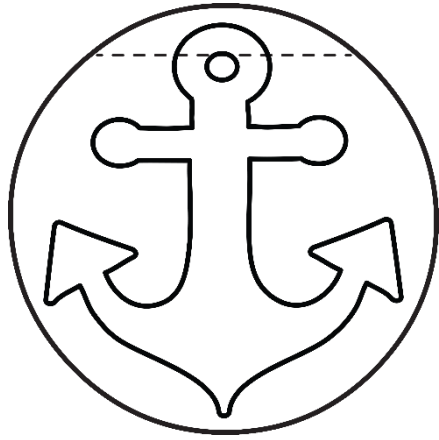

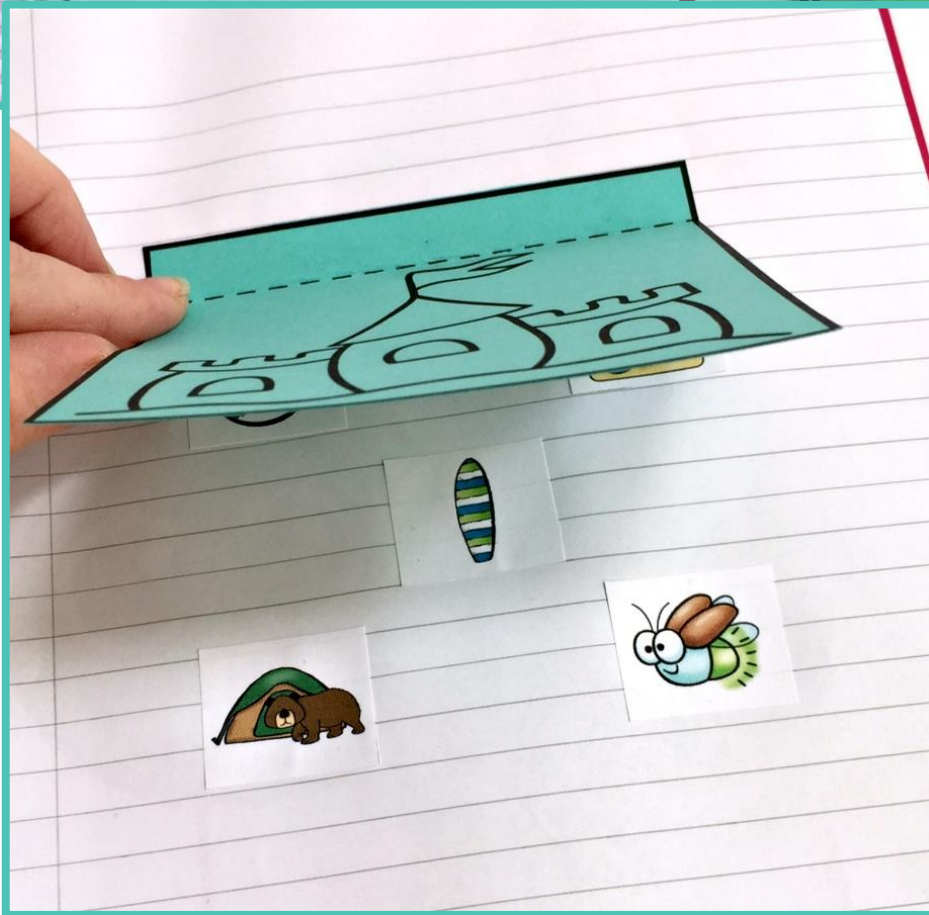
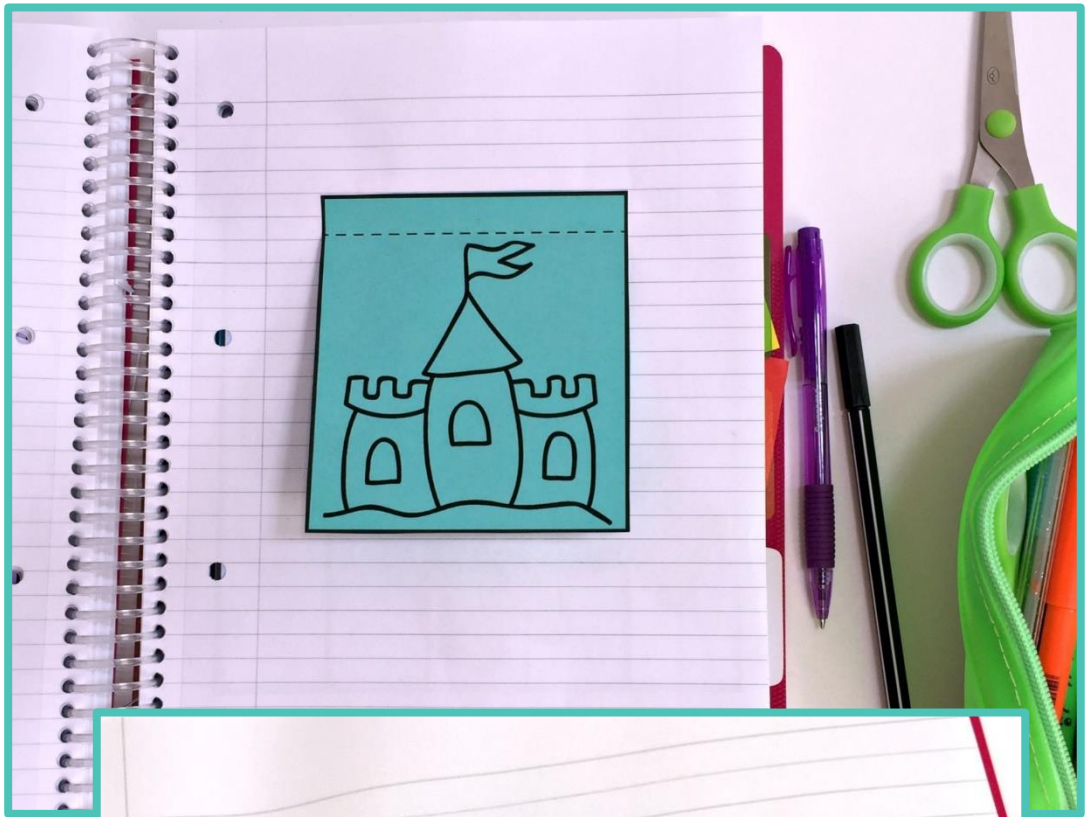

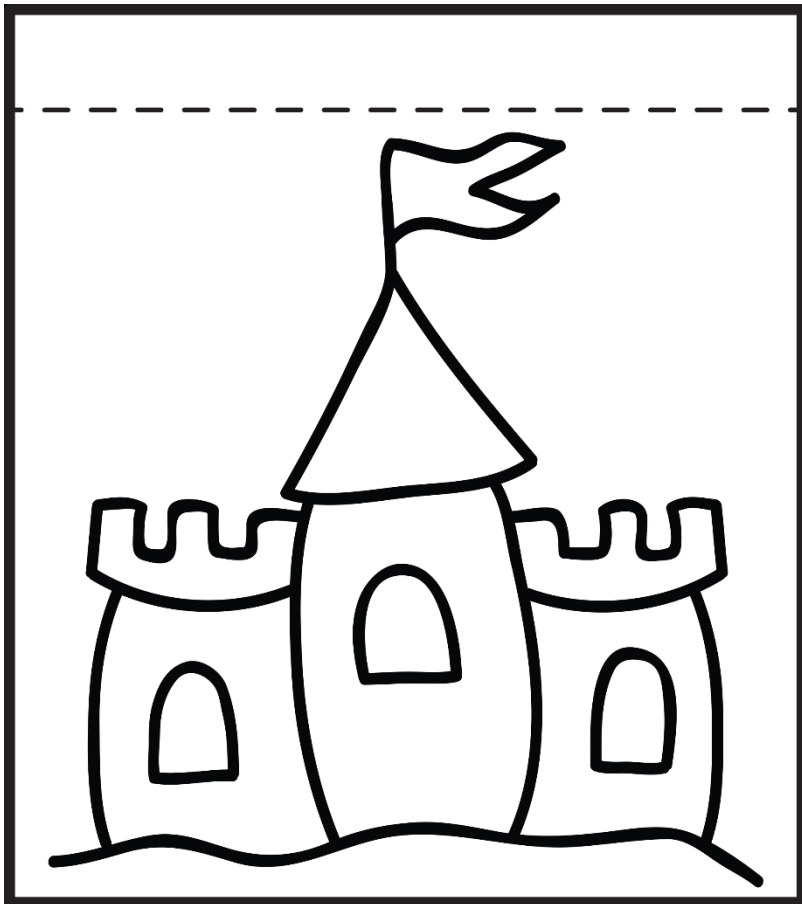
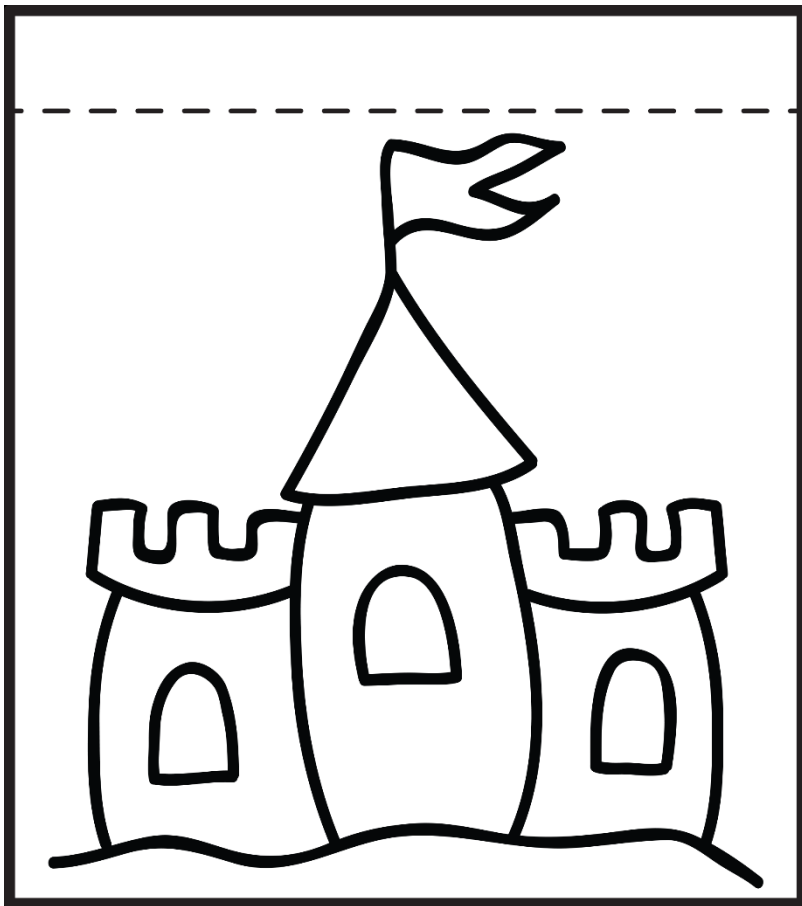

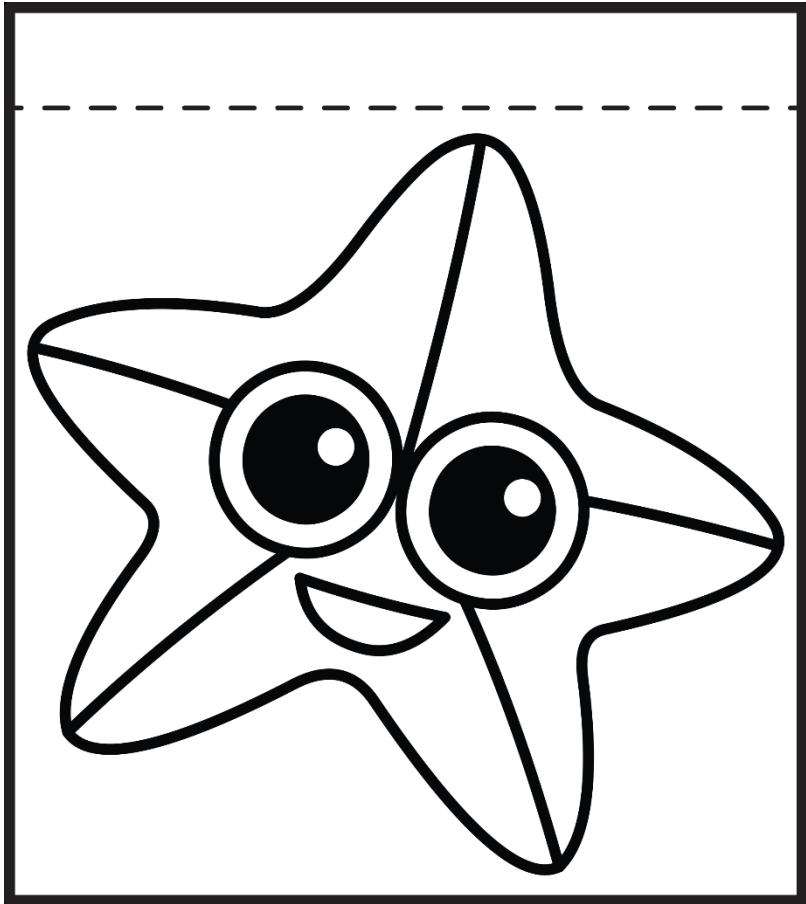
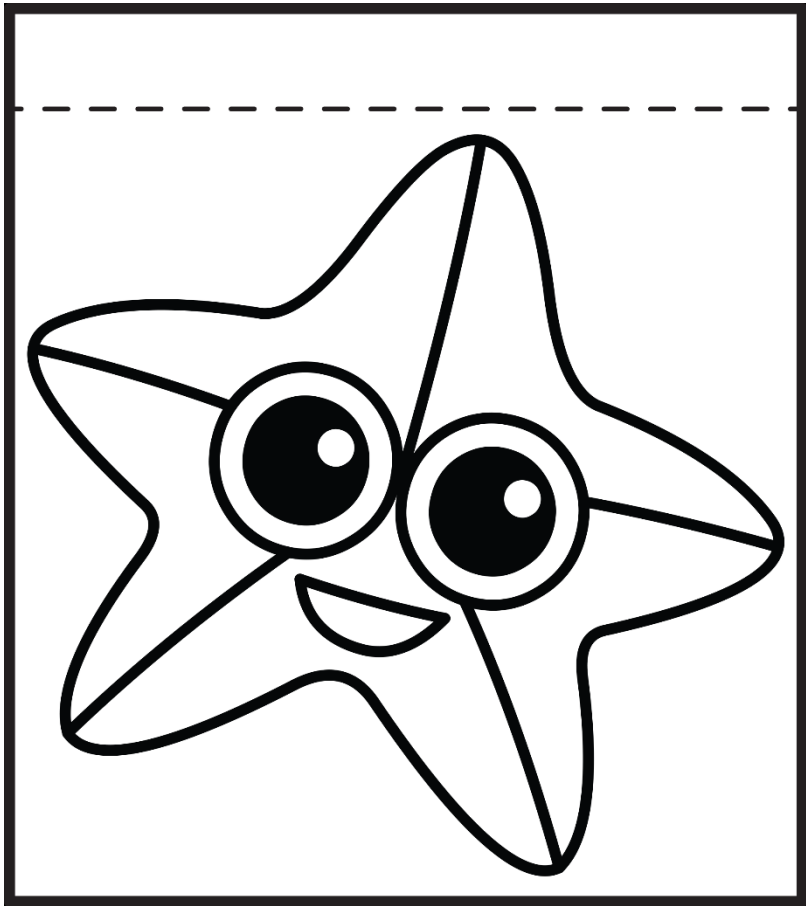

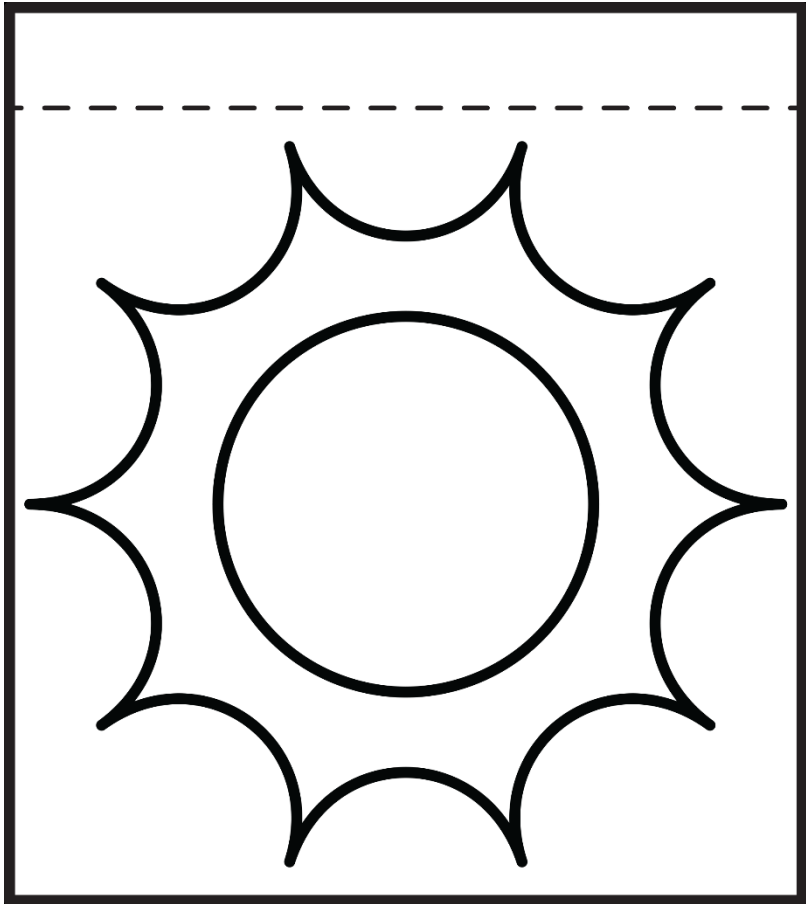
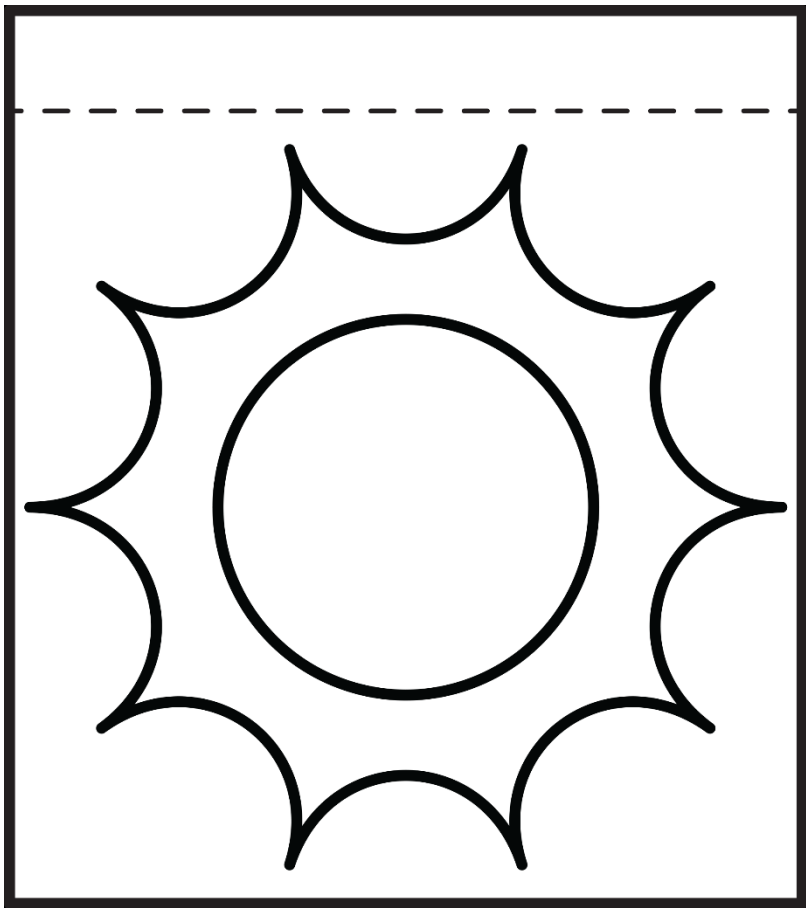

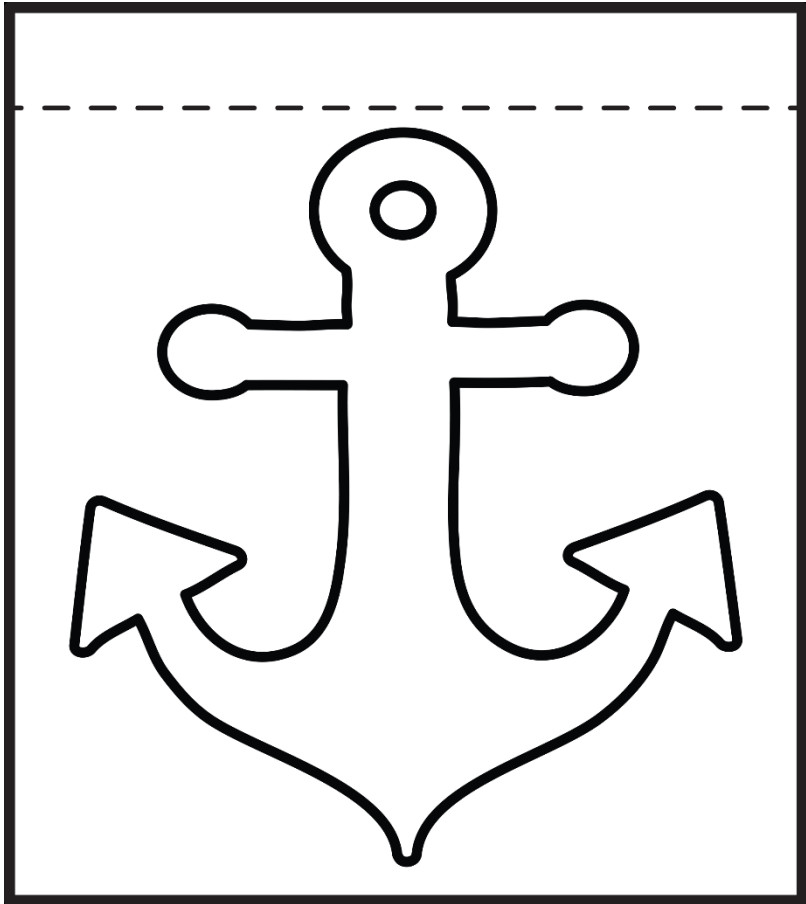
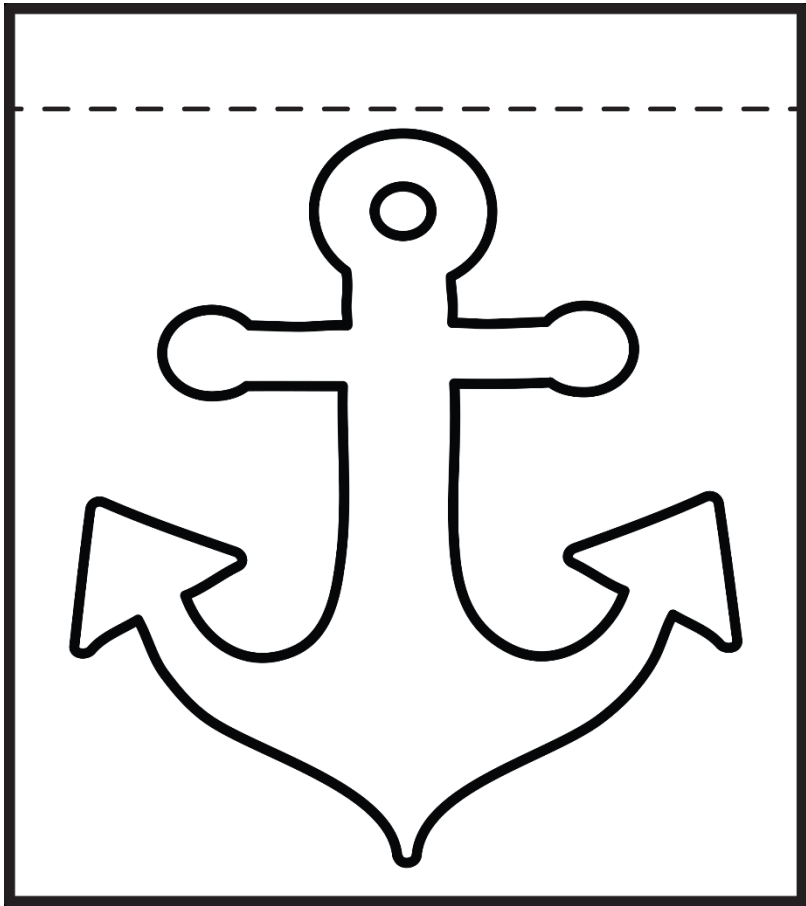

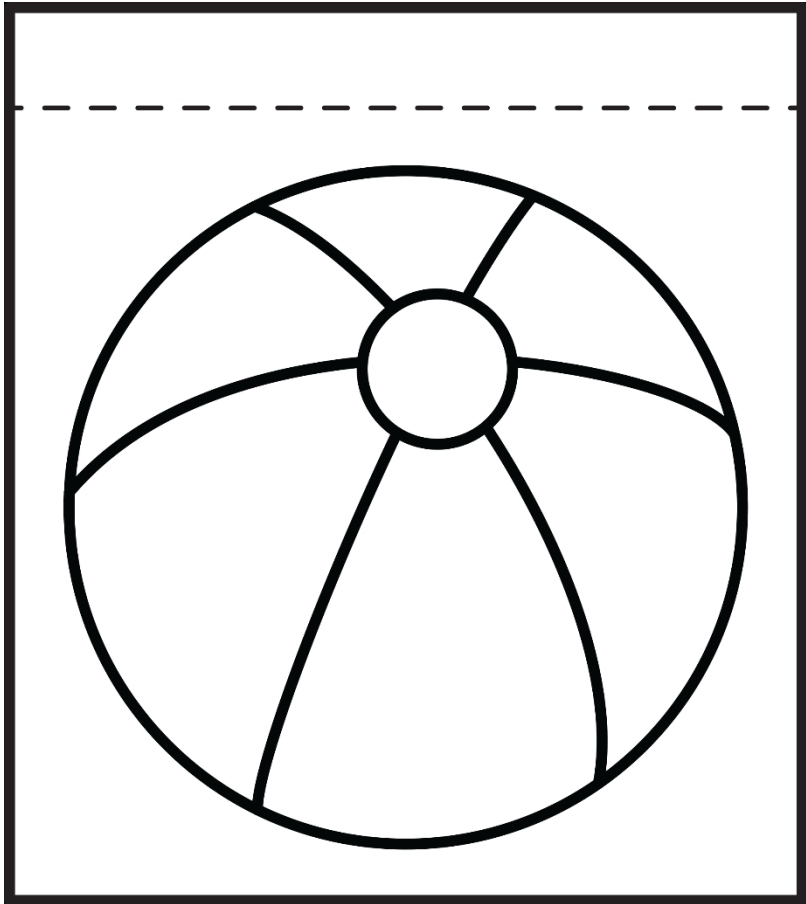
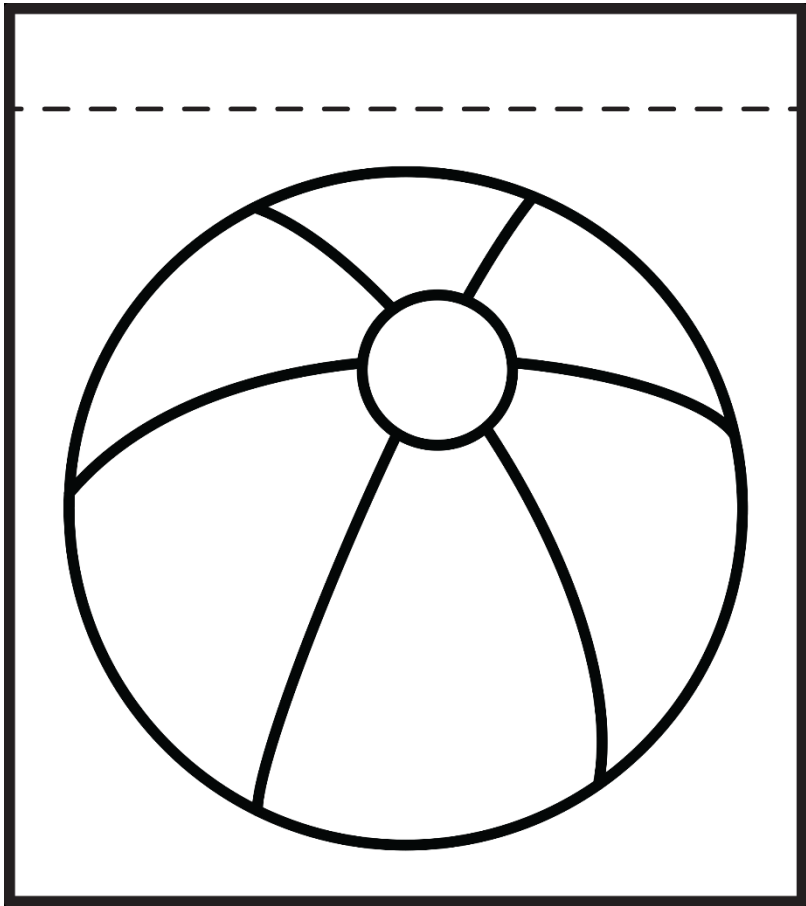

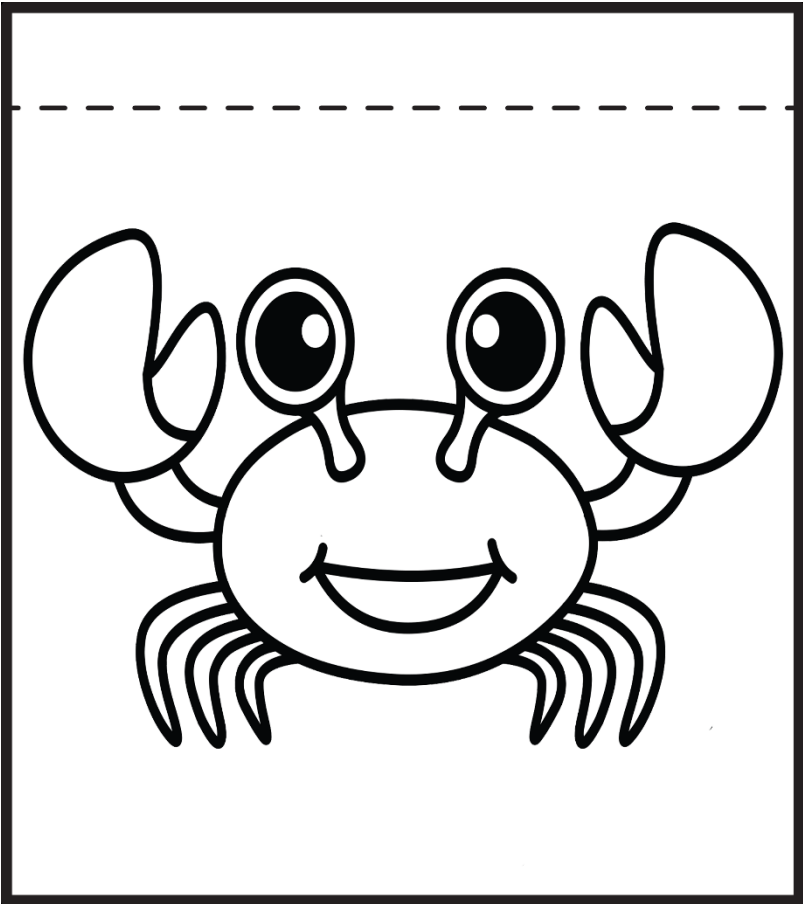
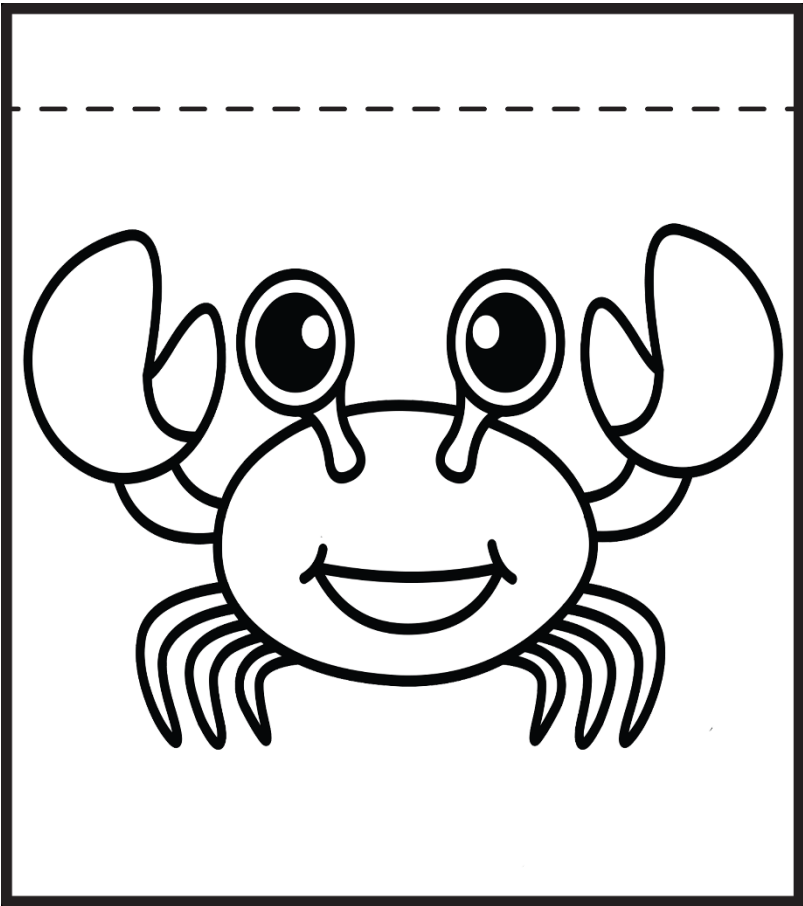

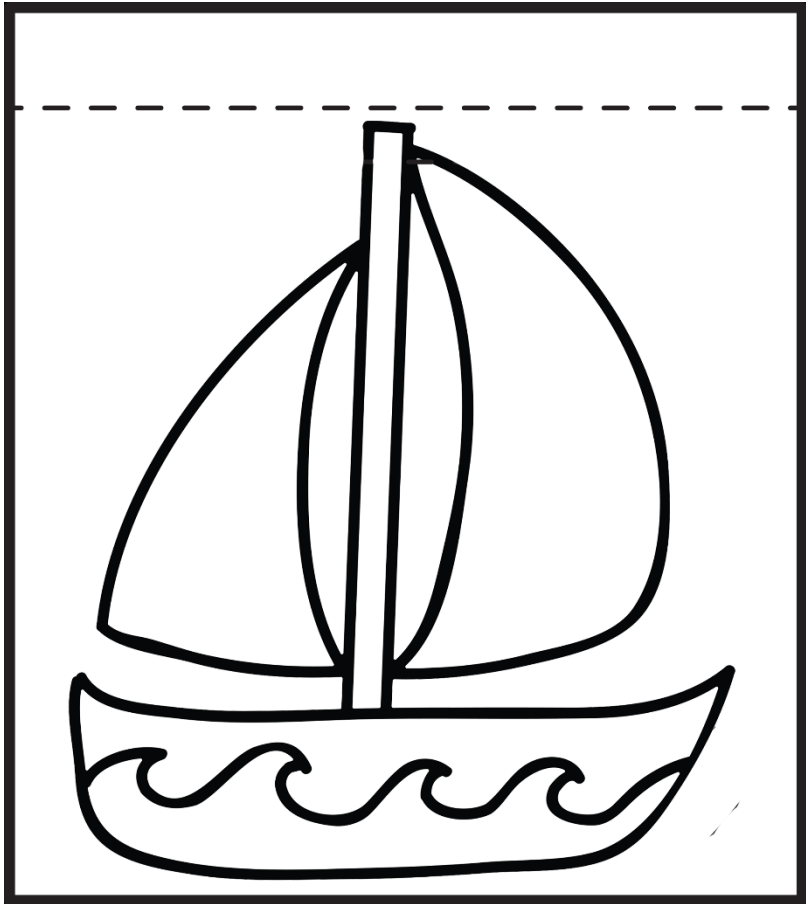
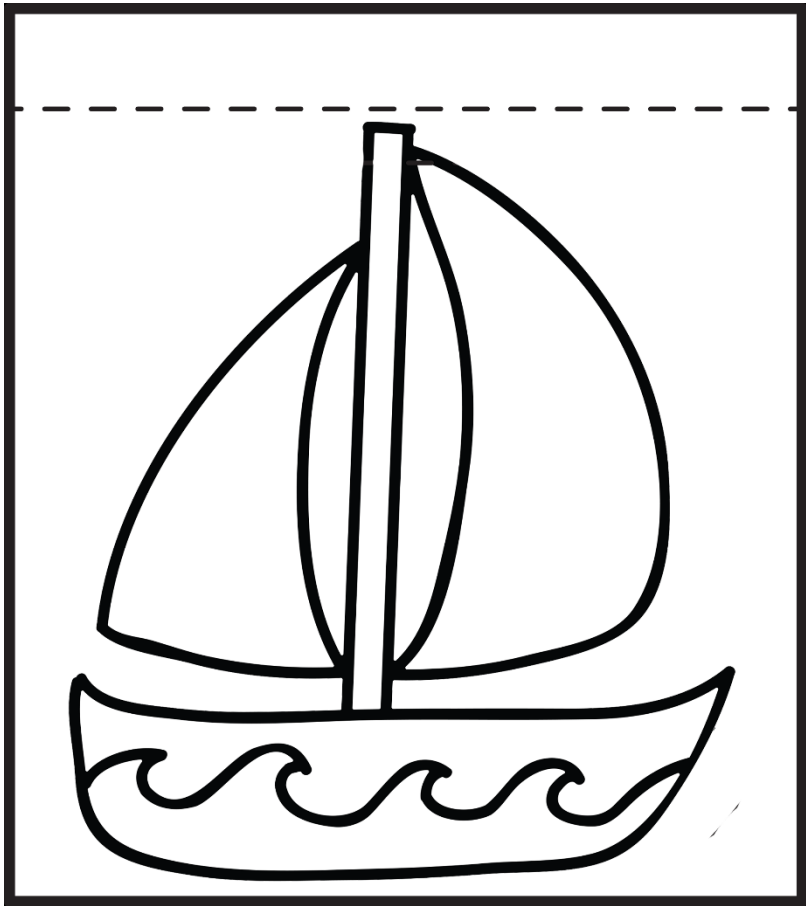

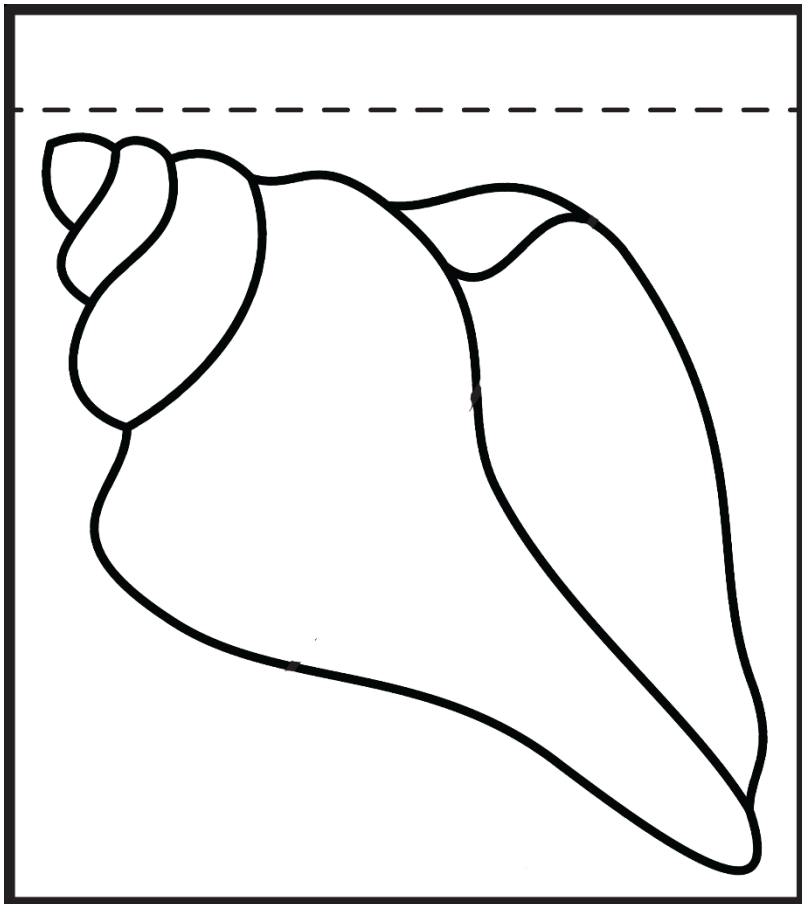
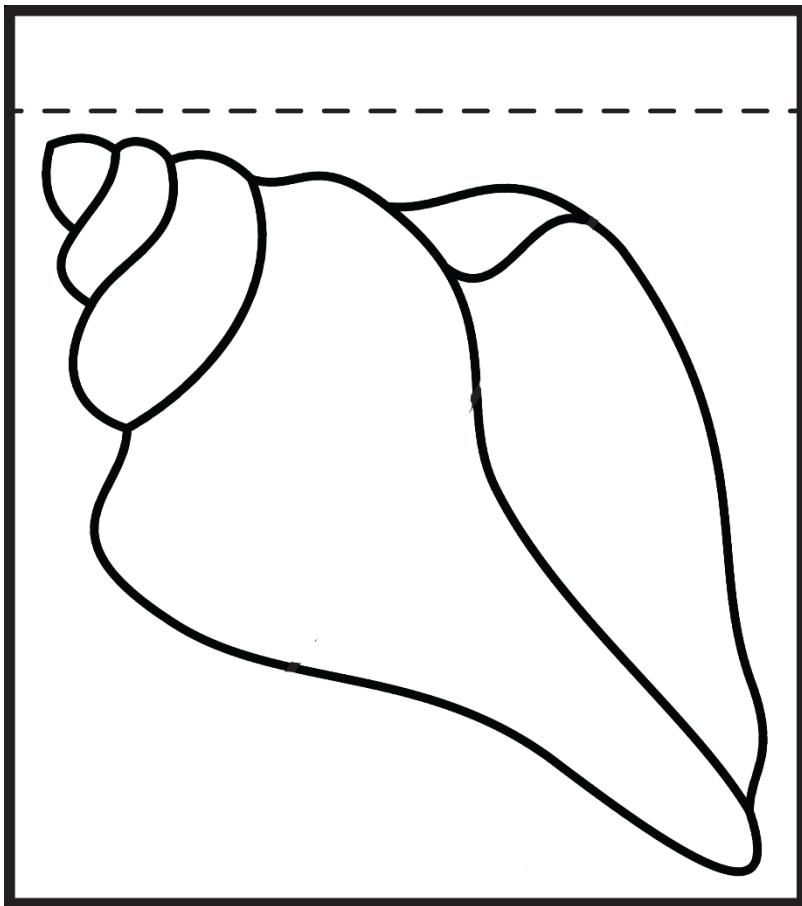



Print the following page on colorful cardstock.

Glue the suns flat into your notebook.

Fold at the dotted line on the circle templates to create a small flap.

With a tiny dab of glue attach one flap to each sun.

Now you're ready to practice!

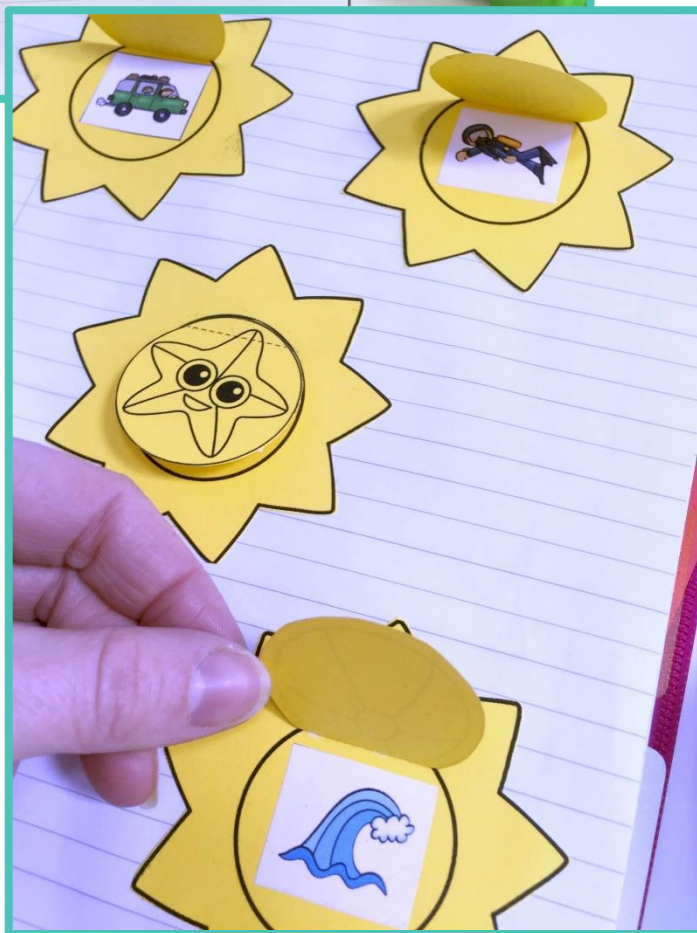

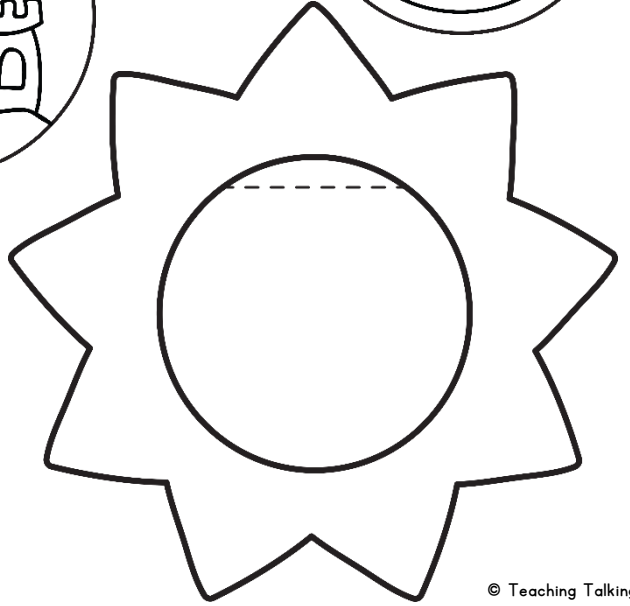
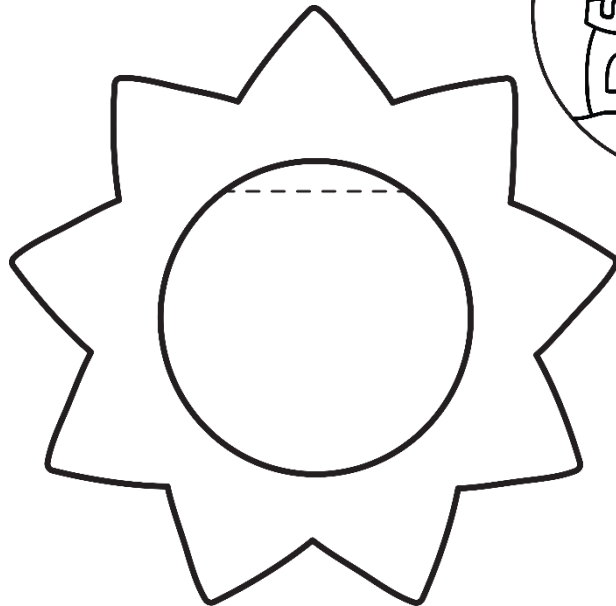
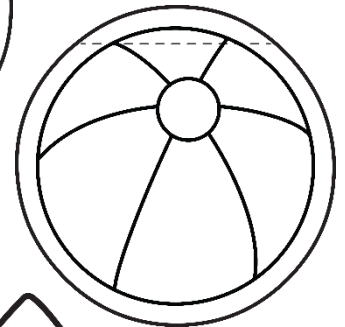
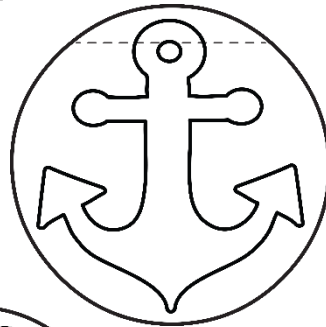
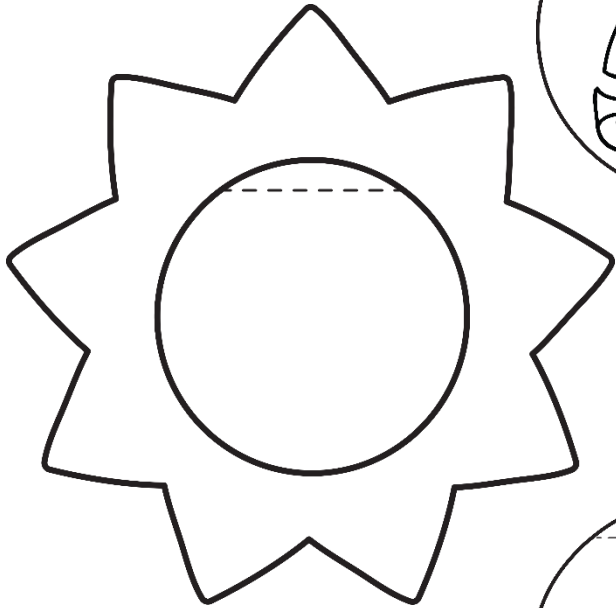
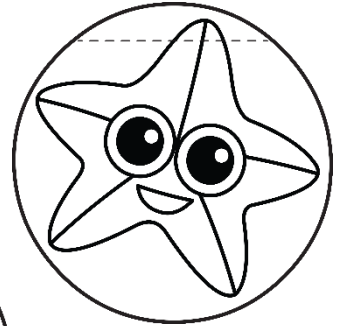
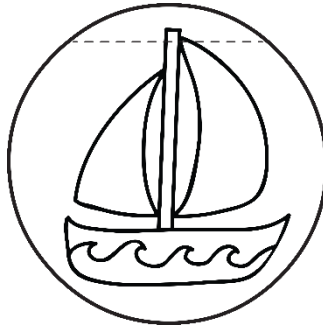
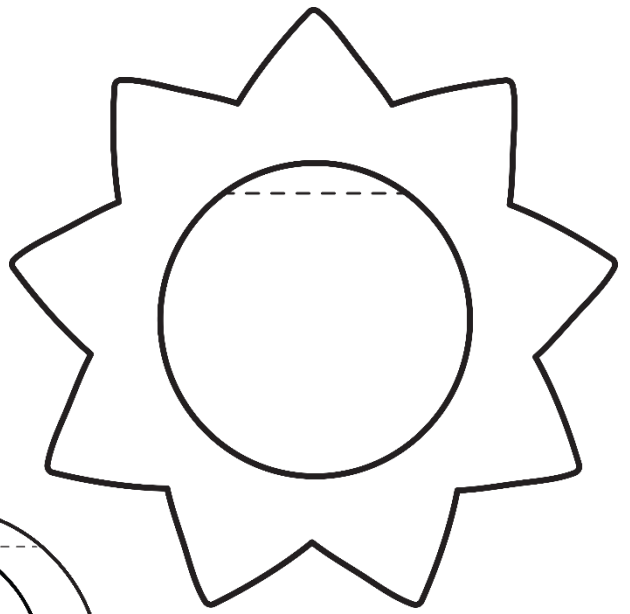
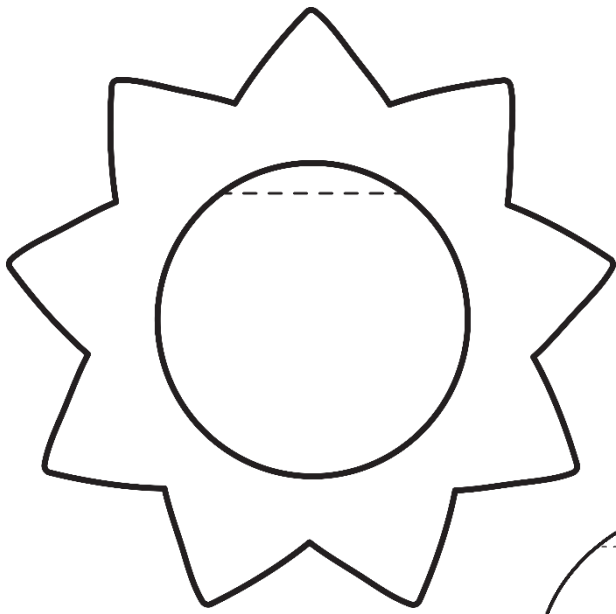



In this section you will find "double - door" flap templates. Make the cut up through the center of the image last, after it has been stuck into the notebook.



Sunny Sounds

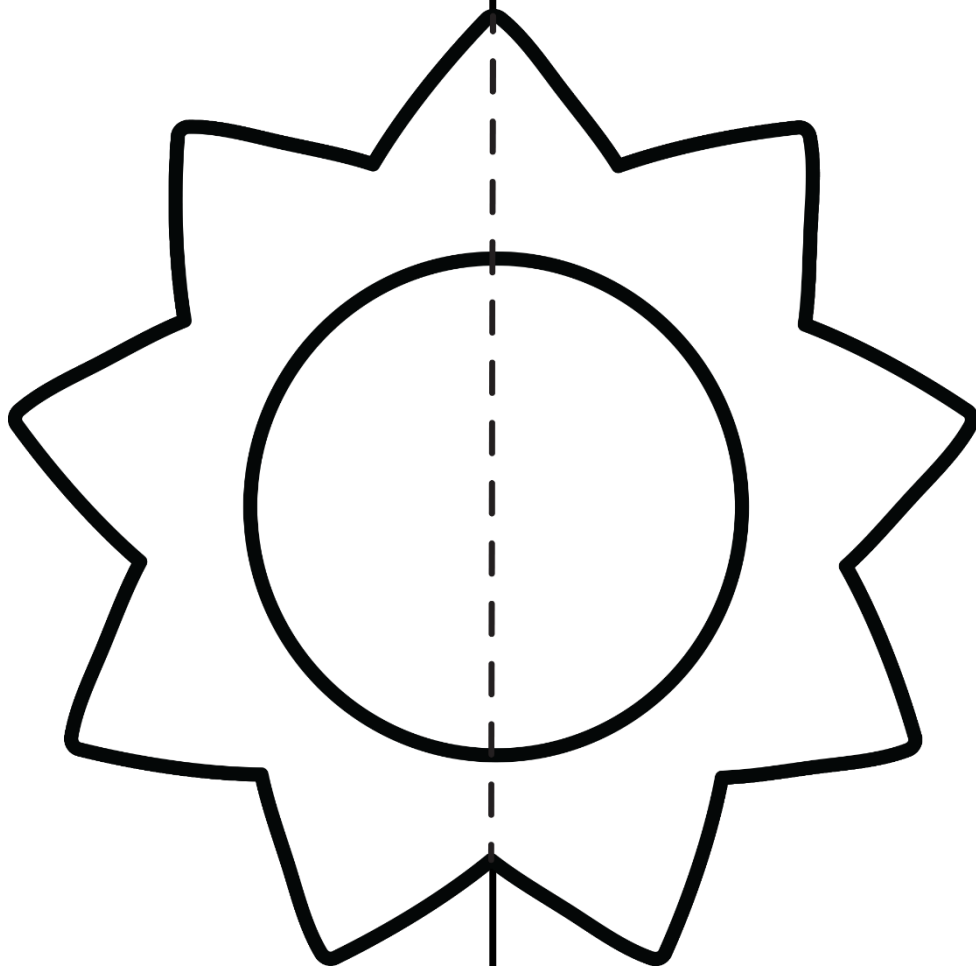

Sunny Sounds

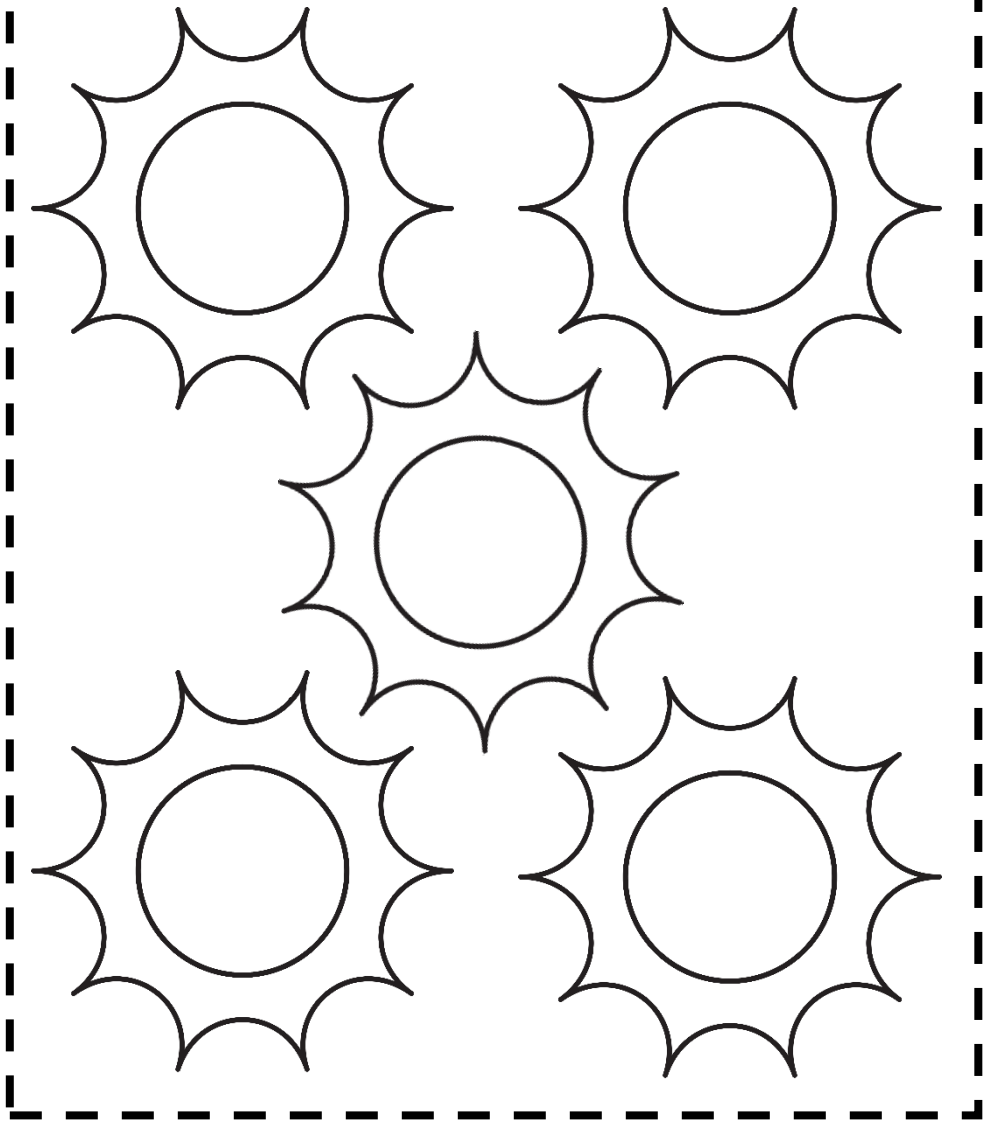

Having a Ball

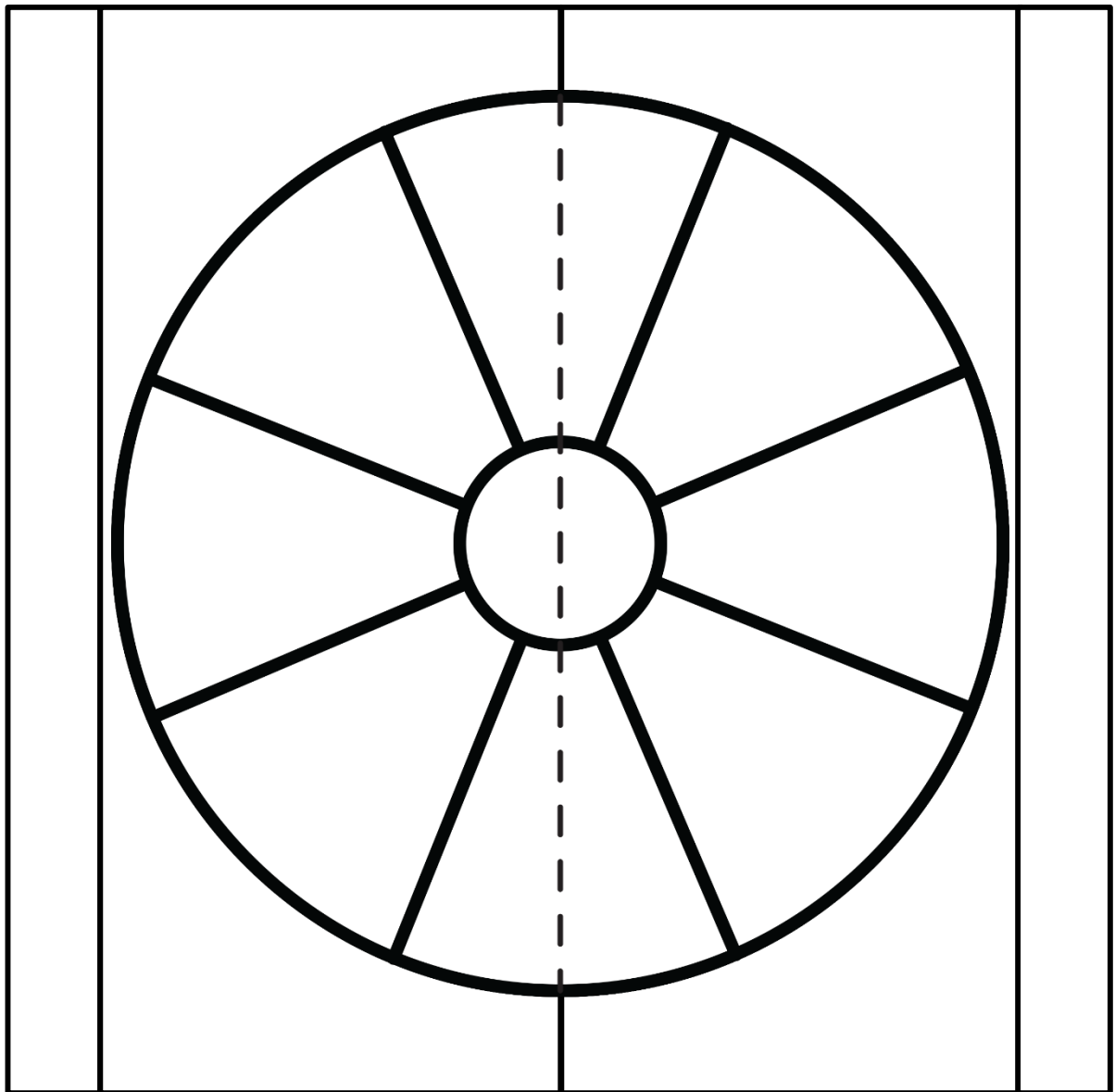

Having a Ball

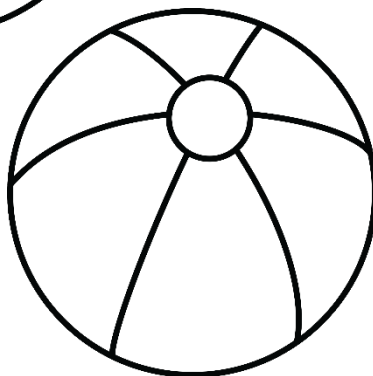
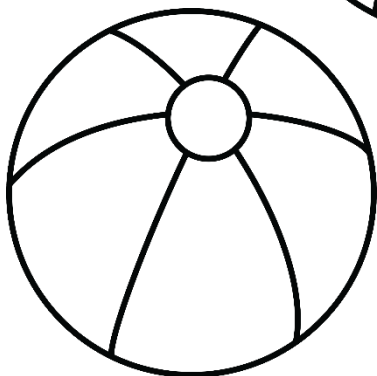
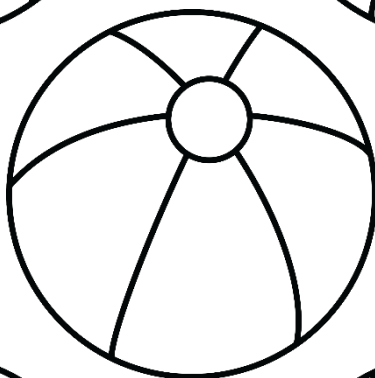
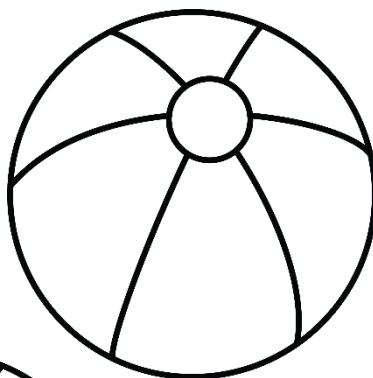
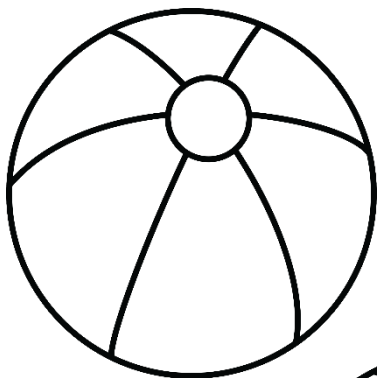

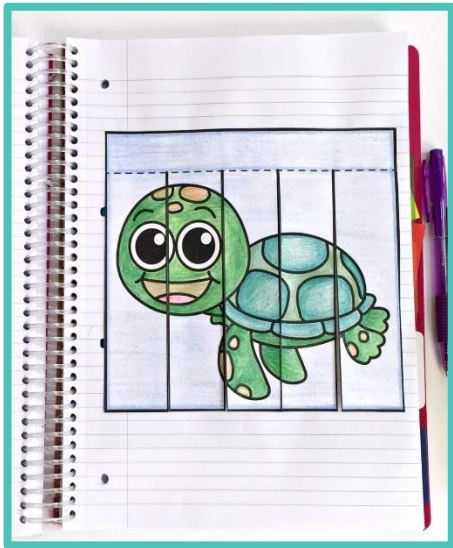

The templates in this section are sized to neatly house **5** mini-images under each flap. Use them as revision activities to cover all of the sounds you've been working on.

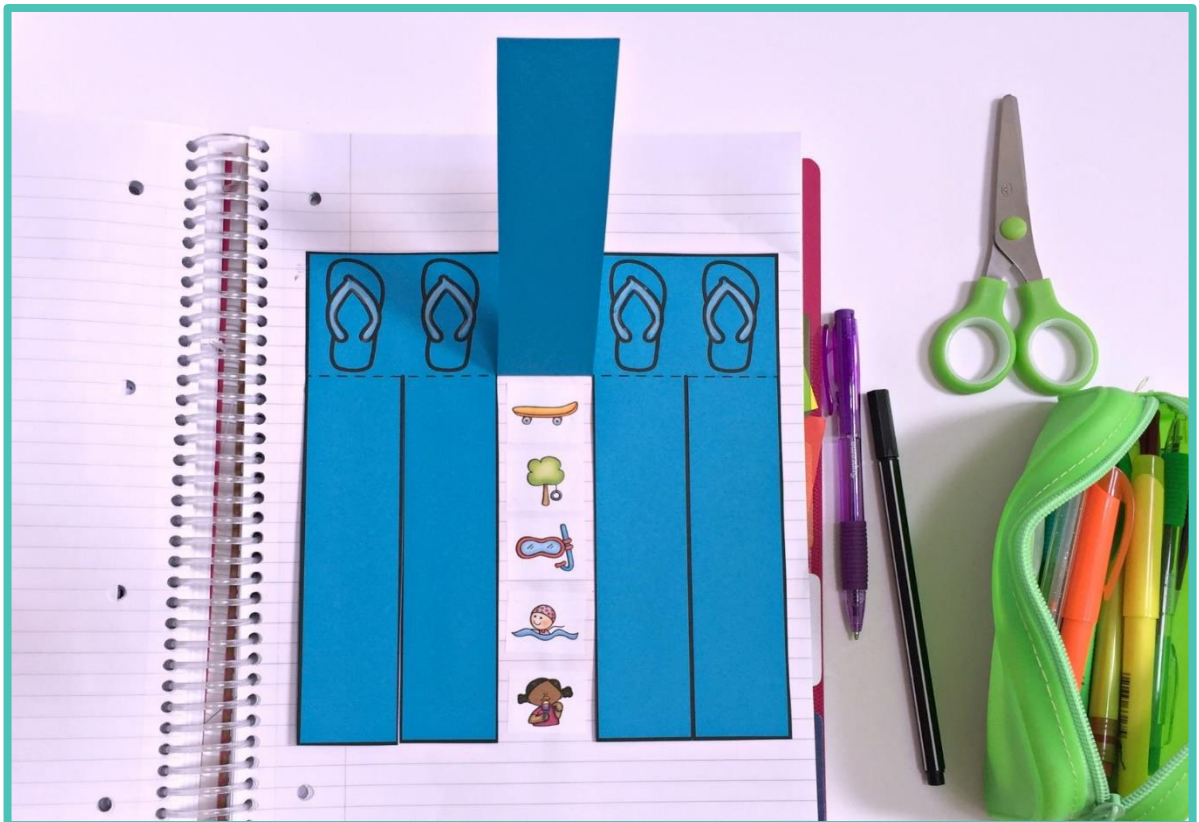

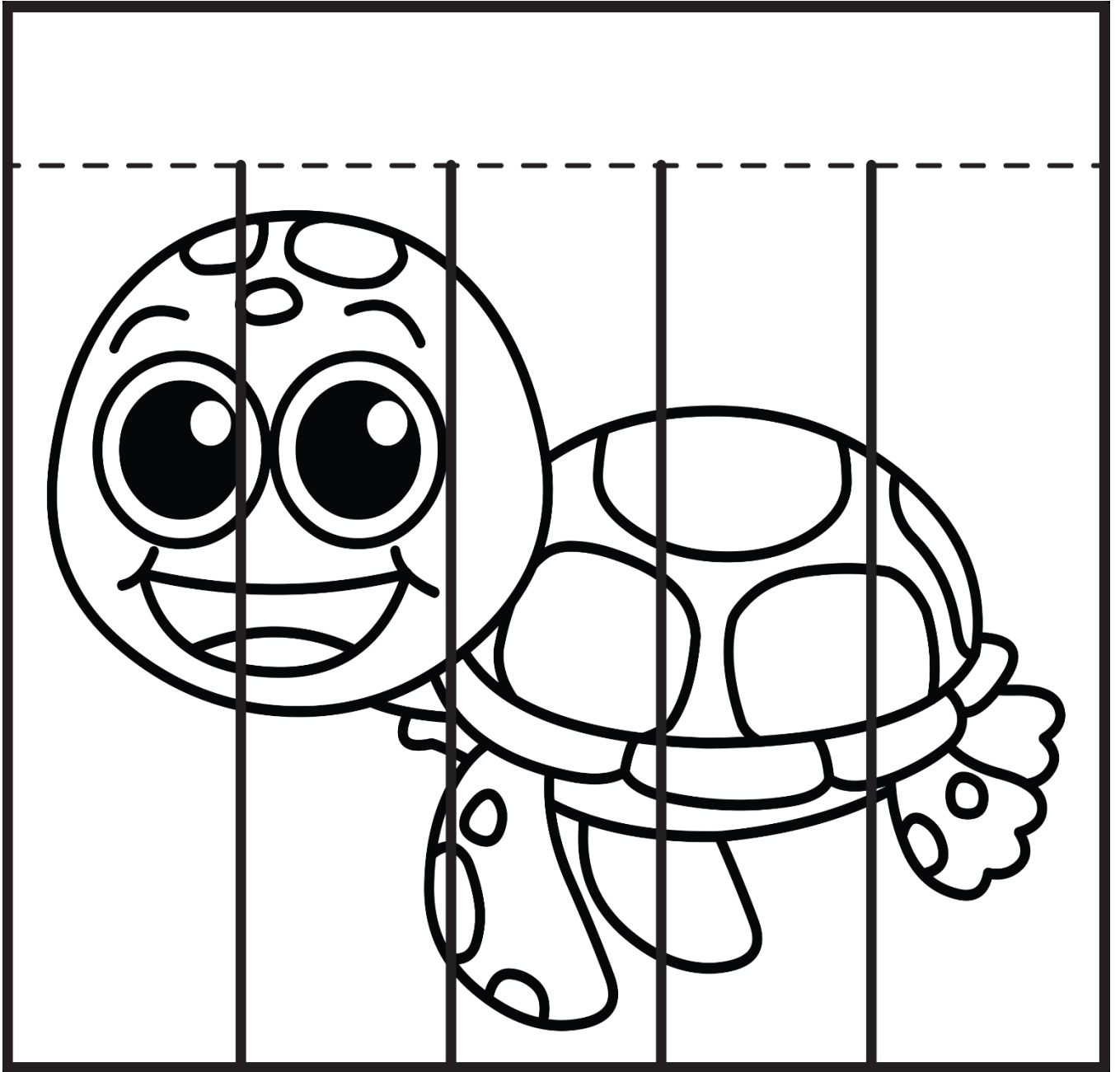



--	--	--	--	--

This templates on the following pages can be glued down inside your notebook to create a multi-layered flap activity.



It also works great as a take-home review flipbook. Print the pages on durable cardstock and cut. Align the straight edges together & staple to create your booklet.

