

Minimal Pairs

Final Consonant Deletion

/s/

8 pairs

Minimal Pairs

Final Consonant Deletion

/s/

Note to SLP: Minimal pairs are accent dependent. You should decide which words will work for your student before beginning practice.

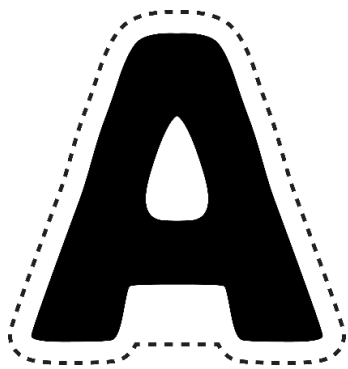

A

Final Consonant Deletion /s/

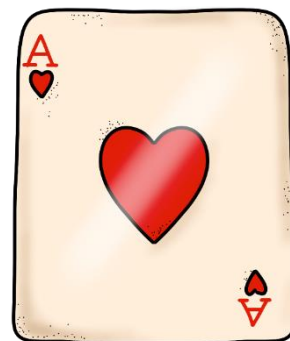

ace

Final Consonant Deletion /s/

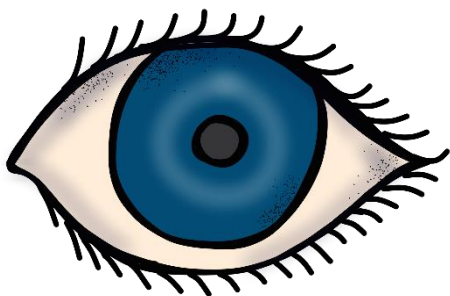

eye

Final Consonant Deletion /s/

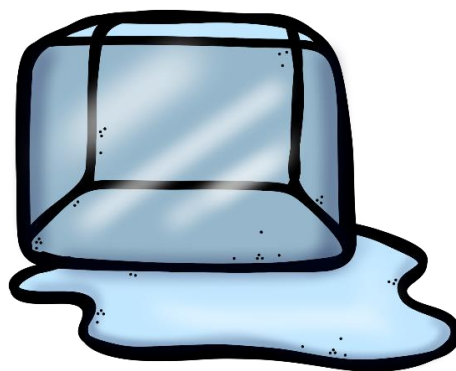

ice

Final Consonant Deletion /s/

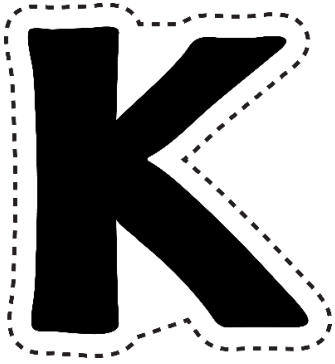

K

Final Consonant Deletion /s/

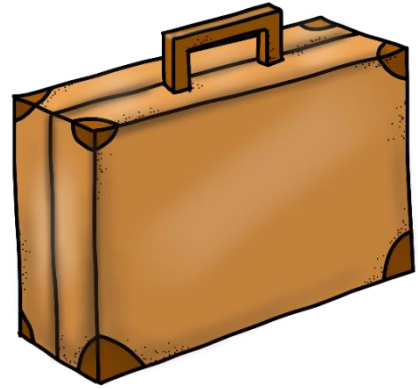

case

Final Consonant Deletion /s/



moo

Final Consonant Deletion /s/



moose

Final Consonant Deletion /s/

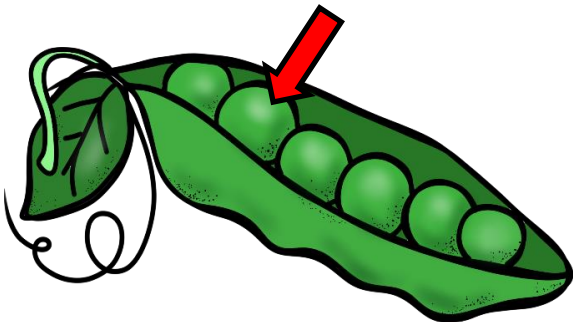

pea

Final Consonant Deletion /s/

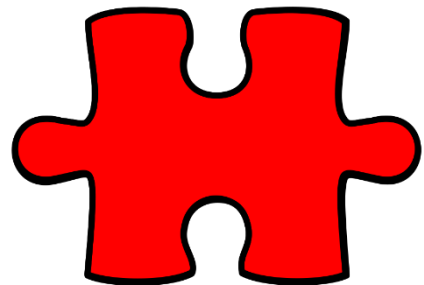

piece

Final Consonant Deletion /s/



my

Final Consonant Deletion /s/

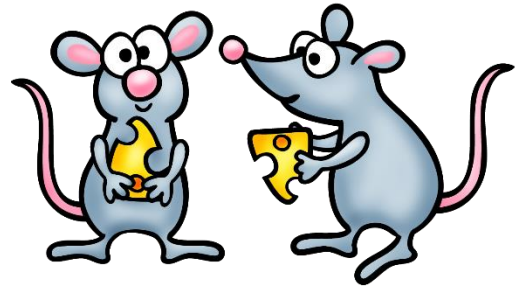

mice

Final Consonant Deletion /s/



die

Final Consonant Deletion /s/

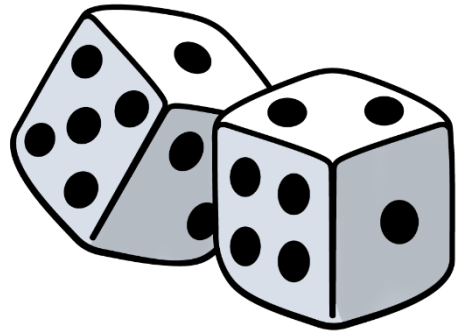

dice

Final Consonant Deletion /s/



four

Final Consonant Deletion /s/



force

Final Consonant Deletion /s/

Minimal Pairs

Final Consonant Deletion

/s/

Note to SLP: Minimal pairs are accent dependent. You should decide which words will work for your student before beginning practice.

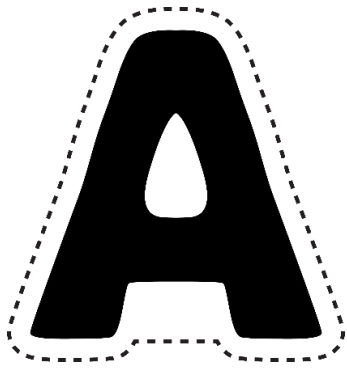

A

Final Consonant Deletion /s/

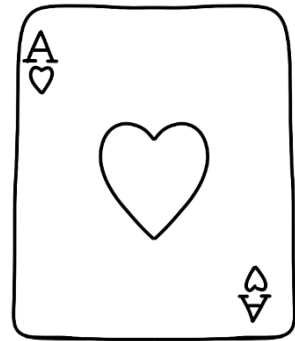

ace

Final Consonant Deletion /s/

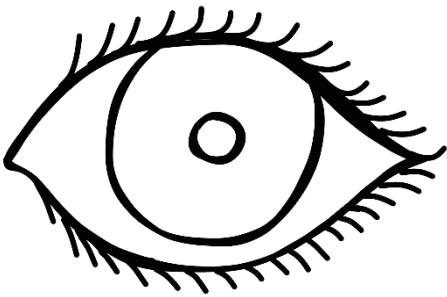

eye

Final Consonant Deletion /s/

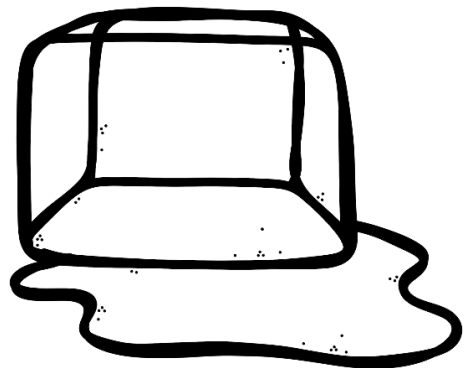

ice

Final Consonant Deletion /s/

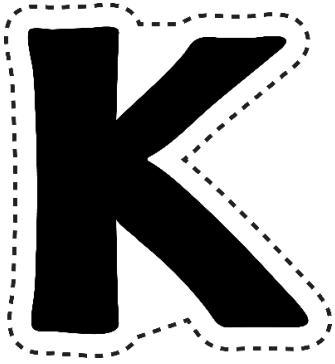

K

Final Consonant Deletion /s/

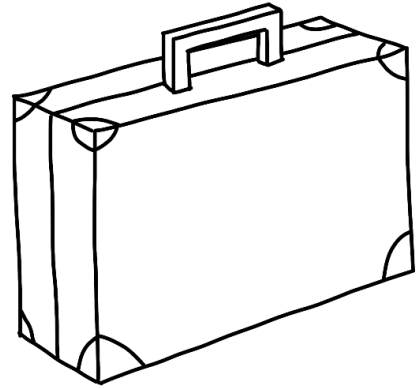

case

Final Consonant Deletion /s/

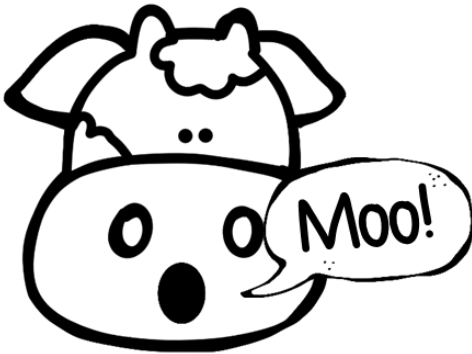

moo

Final Consonant Deletion /s/



moose

Final Consonant Deletion /s/

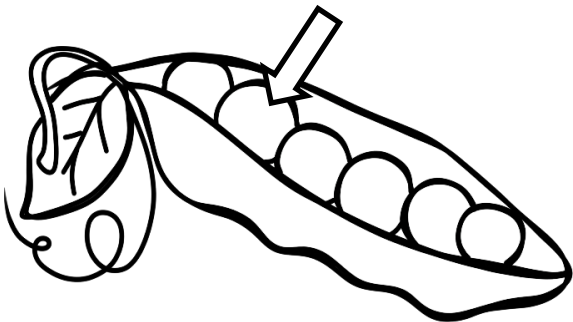

pea

Final Consonant Deletion /s/

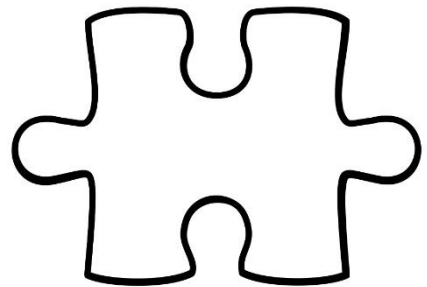

piece

Final Consonant Deletion /s/



my

Final Consonant Deletion /s/

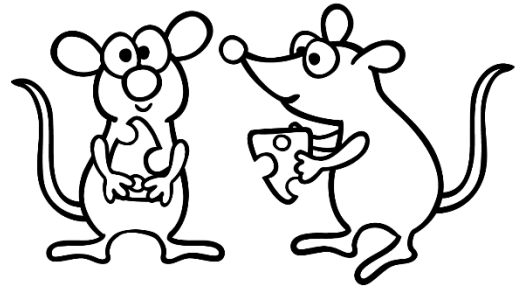

mice

Final Consonant Deletion /s/

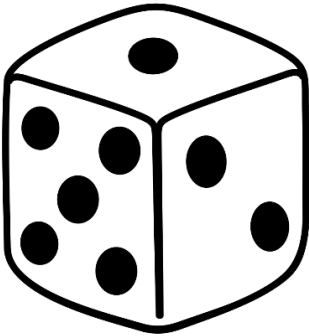

die

Final Consonant Deletion /s/

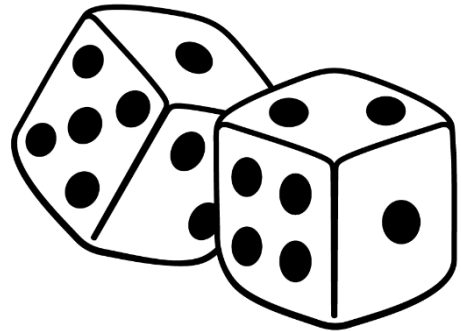

dice

Final Consonant Deletion /s/

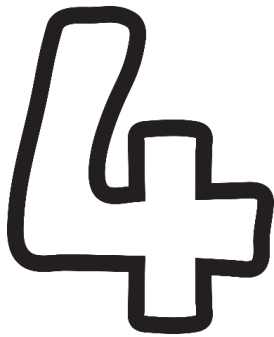

four

Final Consonant Deletion /s/

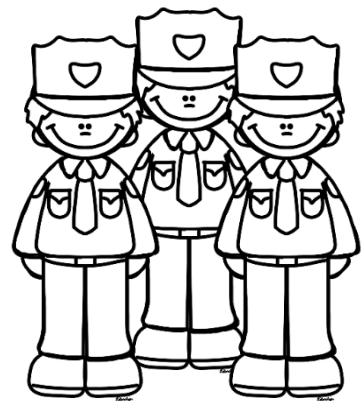

force

Final Consonant Deletion /s/